



Dichiarazione CE di conformità
EC declaration of conformity

Torino, 1/1/2010

REER SpA
via Carcano 32
10153 – Torino
Italy

dichiara che le barriere fotoelettriche **EOS4** sono Dispositivi Elettrosensibili di Sicurezza (ESPE) di :

- **Tipo 4** (secondo la Norma **CEI EN 61496-1:2005; CEI EN 61496-2:2007**)
- **SIL 3** (secondo la Norma **CEI EN 61508:2002**)
- **SILCL 3** (secondo la Norma **CEI EN 62061:2005 + CEI EN 62061/EC2:2008**)
- **PL e** (secondo la Norma **UNI EN ISO 13849-1:2008**)

declares that the **EOS4** photoelectric safety barriers are :

- **Type 4** (according the Standard **IEC 61496-1:2004; IEC 61496-2:2006**)
- **SIL 3** (according the Standard **IEC 61508:1998**)
- **SILCL 3** (according the Standard **IEC 62061:2005**)
- **PL e** (according the Standard **ISO 13849-1:2006**)

Electro-sensitive Protective Equipments (ESPE)

realizzati in conformità alle seguenti Direttive Europee:
complying with the following European Directives:

- **2006/42/CE** "Direttiva Macchine"
"Machine Directive"
- **2004/108/CE** "Direttiva Compatibilità Elettromagnetica"
"Electromagnetic Compatibility Directive"
- **2006/95/CE** "Direttiva Bassa Tensione"
"Low Voltage Directive"

e sono identiche all'esemplare esaminato ed approvato con esame di tipo CE da:
and are identical to the specimen examined and approved with a CE - type approval by:

TÜV SÜD Rail GmbH – Ridlerstrasse 65 – D-80339 – Muenchen – Germany

Carlo Pautasso
Direttore Tecnico
Technical Director

Giancarlo Scaravelli
Presidente
President

EOS4 SAFETY LIGHT CURTAIN

SUMMARY

INTRODUCTION	3
PRINCIPLE OF OPERATION	4
INSTALLATION	5
Positioning	6
Master/Slave Positioning	7
Calculation of safety distance	8
Multiple systems	9
Use of deflecting mirrors	10
Distance from reflective surfaces	11
Mechanical assembly and optical alignment	12
Vertical positioning of the light curtain	13
Models with 14, 20mm resolution	13
Models with 30, 40mm resolution	13
Models with 50, 90mm resolution	13
Multibeam Models	14
Horizontal positioning of the light curtain	14
Electrical connections	15
Layout of the connectors on MASTER/SLAVE light curtain	15
Emitter connections	16
Receiver connections	17
Warnings regarding connection cables	18
Configuration and operating modes (Master Models / With integrated control functions)	19
Automatic operation	19
Manual operation	19
Connection of external contactors K1 and K2	20
Examples of connection with REER safety modules	21
OPERATION AND TECHNICAL DATA	24
Light signals	24
Emitter light signals	24
Receiver light signals	24
TEST function	25
Status of the outputs	25
Technical specifications	26
Dimensions	31
CHECKOUTS AND MAINTENANCE	32
Checking of light curtain efficiency	32
Troubleshooting	33
Accessories/Spares	35
GUARANTEE	36

English



ABBREVIATIONS AND SYMBOLS USED IN THIS MANUAL

FE = Functional earth (earth connection)

M/S = Master/Slave System

OSSD = Output Signal Switching Device = Light curtain's solid state safety outputs

TX = Safety light curtain emitter.

RX = Safety light curtain receiver.



Hand protection light curtains



Arm and leg protection light curtains.



Full body protection light grids.



This symbol indicates an important warning for **personal safety**. Failure to comply with this warning may result in high level risk for exposed personnel.



This symbol indicates an important warning.

INTRODUCTION

The EOS4 light curtain is an optoelectronic safety device belonging to the category of Type 4 electro-sensitive protective equipment for the protection of personnel exposed to risks inherent in the use of hazardous machines or plants, complying with the IEC 61496-1,2 and EN 61496-1 standards. The EOS4 is available in three different versions:

1. EOS4 A

Type 4 light curtain consisting of Emitter plus Receiver with automatic reset.



2. EOS4 X (With integrated control functions)

Type 4 light curtain consisting of Emitter plus Receiver with integration of additional functions such as control of feedback from any external contactors and management of manual/automatic operation.

3. EOS4 XM/XS (MASTER/SLAVE)

Type 4 light curtain (with integrated control functions) comprising two (or three) TX/RX pairs (connected in series), one of which comprising the MASTER light curtain (with integrated functions) and one (or two) the SLAVE light curtain.

A set of indicator leds on the Emitter and Receiver provide the information needed for a correct use of the device and for the assessment of any malfunction. The automatic fault sensing system permits independent detection by the EOS4 light curtain of any dangerous fault in a time equal to the light curtain response time.

-  For any safety problem, if necessary, consult the safety authorities of the country of use or the competent industrial association.
-  For applications in the food industry, consult the manufacturer to verify compatibility of light curtain materials with the chemical agents used.
-  The protection capability of optoelectronic safety devices is not effective in cases in which:
 - The machine stopping device cannot be actuated electrically and it is not possible to stop all dangerous machine movements immediately and at any time during the operating cycle.
 - The hazardous condition is associated with the falling of objects from above or ejection of these from the machine.
 - Anomalous forms of light radiation are present (for example, use of cableless control devices on cranes, radiation from weld spatter, etc).In this case additional measures may be necessary to ensure that the ESPE does not fail to danger.

PRINCIPLE OF OPERATION

If the protected area is clear, the two outputs on the Receiver are active and enable the machine to which they are connected to operate normally.

Each time that an object bigger than or equal in size to the resolution of the system intercepts the optical path of one or more beams, the Receiver deactivates its own outputs. This condition enables hazardous machine movements to be stopped (by means of an adequate machine emergency stop circuit).

➔ Resolution is the smallest sized object that, passing through the protected area, interrupts at least one of the beams generated by the light curtain (Figure 1), causing certain intervention of the device and consequent stopping of the hazardous movement of the machine.

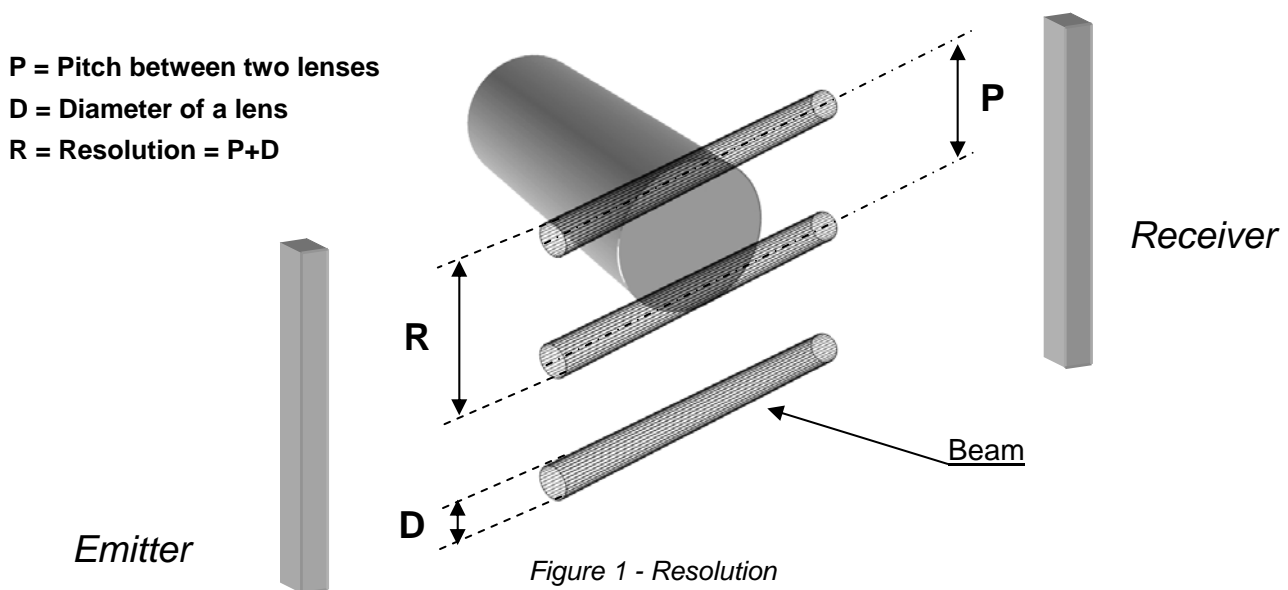

Resolution remains constant regardless of working conditions as it depends only on the geometric characteristics of the mirrors and on the centre distance between two adjacent lenses.

The height of the protected area is the effective height protected by the safety light curtain. If the curtain is positioned horizontally, this value indicates the depth of the protected area.

The working range indicates how far the emitter and receiver can be separated and function properly.

EOS4 is available with the following resolutions:







- 14mm (protected heights from 150mm to 1500mm): PROTECTION OF THE FINGERS.
- 20mm (protected heights from 150mm to 1500mm): PROTECTION OF THE FINGERS.
- 30mm (protected heights from 150mm to 1500mm): PROTECTION OF THE HANDS.
- 40mm (protected heights from 300mm to 1500mm): PROTECTION OF THE HANDS.
- 50mm and 90mm (protected heights from 300mm to 1800mm): PROTECTION OF THE LIMBS.

The EOS4 is also available in a Multibeam version with a distance between the mirrors of:

- 500mm (2 beams), 400mm (3 beams), 300mm (4 beams). PROTECTION OF THE BODY.

INSTALLATION



Before installing the EOS4 safety system, check all the conditions listed below:

-  The level of protection of EOS4 (Type 4, SIL3, SILCL3 PLe) must be compatible with the level of danger of the system to be protected.
-  The safety system is used only as a stopping device and not to control the machine.
-  The machine movement is actuated electrically.
-  All dangerous movements of the machine can be interrupted immediately. In particular, the machine stopping times must be known and, if necessary, measured.
-  The machine must not generate hazards due to projection or falling of materials from above; otherwise, additional mechanical guarding must be provided.
-  The smallest size object to be detected must be greater than or equal to the resolution of the selected model.

Knowing the shape and dimensions of the dangerous area, it is possible to calculate the width and height of the related access area :

-  Compare these dimensions with the maximum working range and the height of the protected area of the model used.

Before positioning the safety device, comply with the following general indications:

-  Check that the temperature of the environment in which the system is installed is compatible with the operating temperature parameters indicated on the product label and in the technical data.
-  Do not position the Emitter and the Receiver close to very bright or flashing sources of light.
-  Particular operating conditions may affect the sensing level of photo-electric devices. In environments characterised by fog, rain, fumes or dust, to always guarantee correct operation of the appliance, it is advisable to apply suitable correction factors Cf so as to maximum working range values. In these cases:

$$P_u = P_m \times C_f$$

where P_u and P_m are, respectively, the working and maximum range expressed in metres.

The recommended correction factors CF are indicated in the table below.

OPERATING CONDITIONS	CORRECTION FACTOR Cf
Fog	0.25
Vapours	0.50
Dust	0.50
Dense fumes	0.25

Table 1 – CF correction factors

-  If the device is installed in environments characterised by sudden changes in temperature, suitable precautions must be taken to prevent the formation of condensation on the mirrors, which could impair detection capability.

Positioning

The Emitter *EOS4E* and the Receiver *EOS4R* must be positioned so that it is impossible to access the dangerous area from above, from below and from the sides without intercepting one of the beams. Useful indications for correct positioning of the light curtain are provided in the figure below.

Incorrect positioning of the light curtain

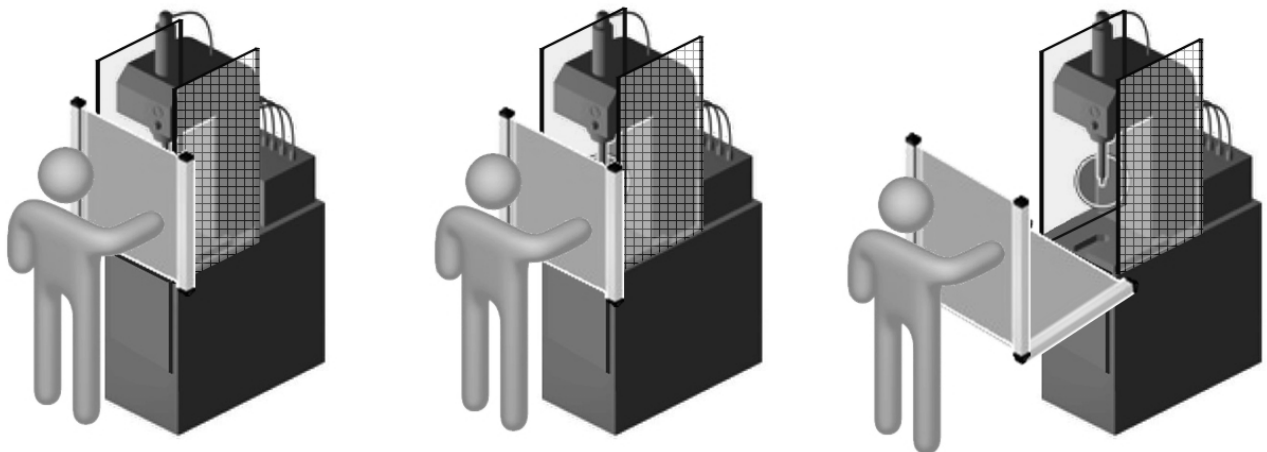
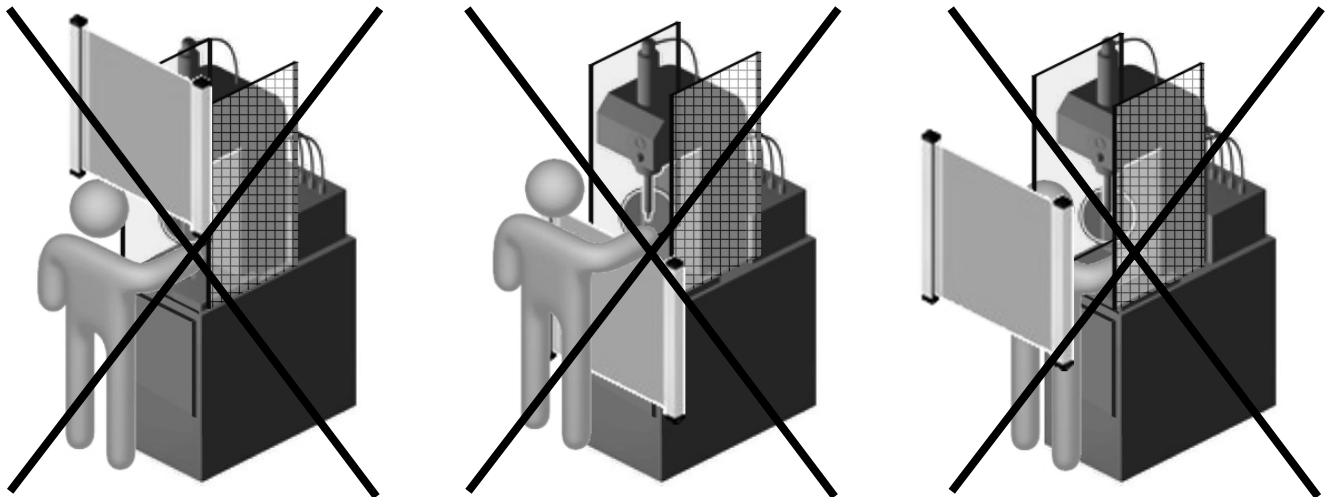

Correct positioning of the light curtain

Figure 2 - Positioning

Master/Slave Positioning

In addition to standard models (that can be positioned either horizontally or vertically), EOS4 can be purchased in a MASTER/SLAVE configuration. This configuration comprises two (or three) pairs of light curtains in which the two (or three) Emitters and the two (or three) Receivers are connected in series.

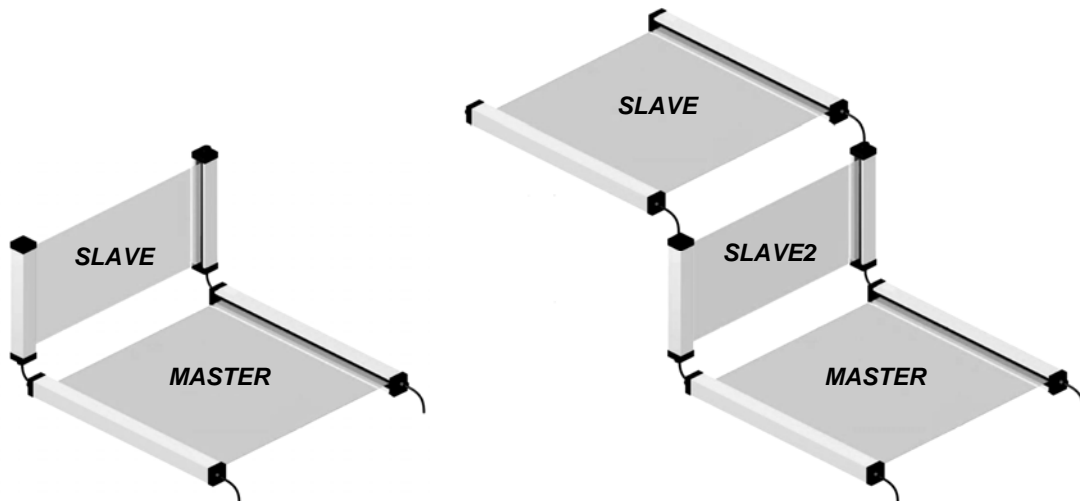

Figure 3 – Examples of Master/Slave configurations

The connection cable between the master and slave may be up to 50 metres in length. This characteristic permits configuration of an application with two light curtains positioned one at the front and one at the rear of the dangerous machine, with a single connection towards the machine power and control circuits (Figure 4).

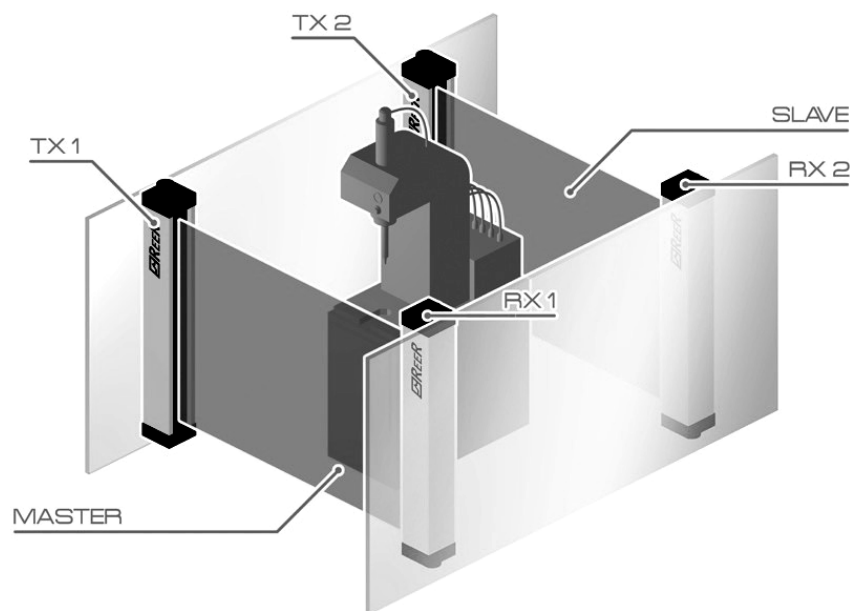

Figure 4 - Example of Master/Slave application with mechanical guards

Calculation of safety distance

The light curtain must be positioned at a distance equal to or greater than the minimum safety distance **S** so that the dangerous point can be reached only after stopping the dangerous movement of the machine (Figure 5).

According to the EN999:2008 European standards, the minimum safety distance **S** must be calculated using the following formula :



$$S = K (t1 + t2) + C$$

$$C = 8 (d-14)$$

where:

S	Minimum safety distance	mm
K	Operator approach speed to the dangerous area	mm/sec
t1	Total response time of the light curtain, in seconds	sec
t2	Response time of the machine in seconds, i.e. the time taken by the machine to stop the dangerous movement from the moment in which the stop signal is transmitted	sec
C	Additional distance that varies according to the application ¹	mm
d	Resolution	mm

Table 2 – Safety distance

-  Failure to comply with the safety distance reduces or impairs the protection function of the light curtain.
-  If positioning of the light curtain does not prevent the operator from accessing the dangerous zone without being detected, additional mechanical guards must be installed.

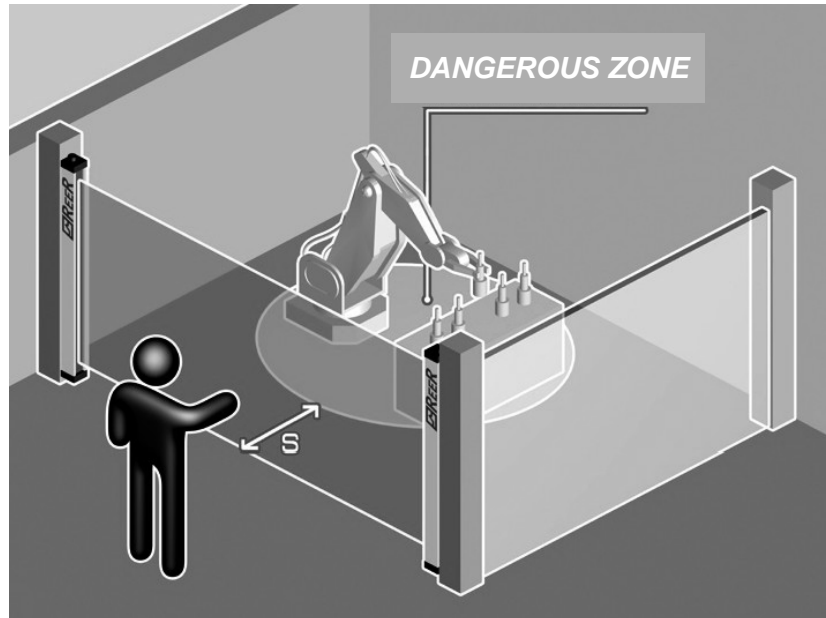

Figure 5 – Safety distance **S**

¹ For further information on additional safety distance, refer to EN999:2008.

Multiple systems

When several EOS4 are used, precautions must be taken to prevent optical interference between these: position the elements so that the beam of the Emitter of one system is received only by its respective Receiver.

Figure 6 provides examples of correct positioning of two photo-electric systems. Incorrect positioning may cause interference, with possible malfunction of the system.

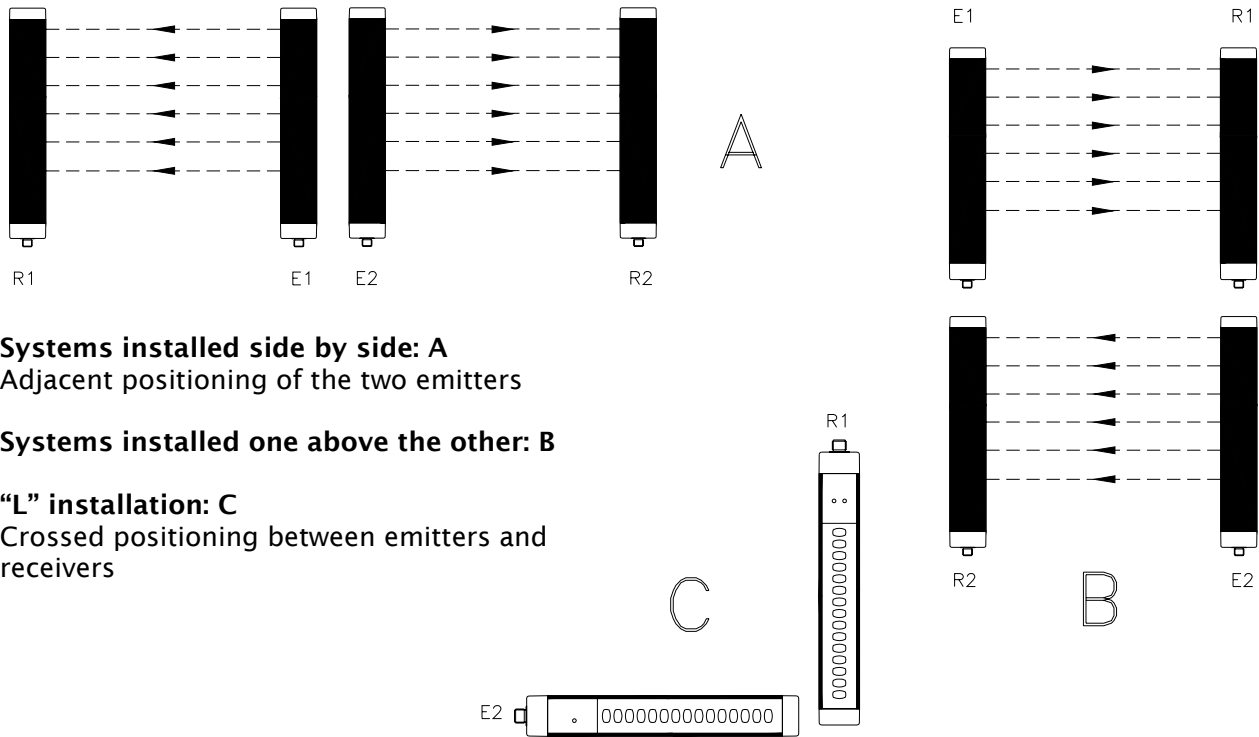

Systems installed side by side: A

Adjacent positioning of the two emitters

Systems installed one above the other: B

"L" installation: C

Crossed positioning between emitters and receivers

Figure 6 – Multiple systems

➔ This precaution is not necessary in the case of MASTER/SLAVE systems.

Use of deflecting mirrors

For protection or control of areas accessible from several sides, one or more deflecting mirrors can be used in addition to the Emitter and Receiver.

Deflecting mirrors make it possible to redirect the beams generated by the Emitter on several sides.

Wishing to deflect the beams generated by the Emitter by 90°, the perpendicular to the surface of the mirrors must form an angle of 45° with the direction of the beams.

An application in which two deflecting mirrors have been used for "U" shaped protection is illustrated in the figure below.

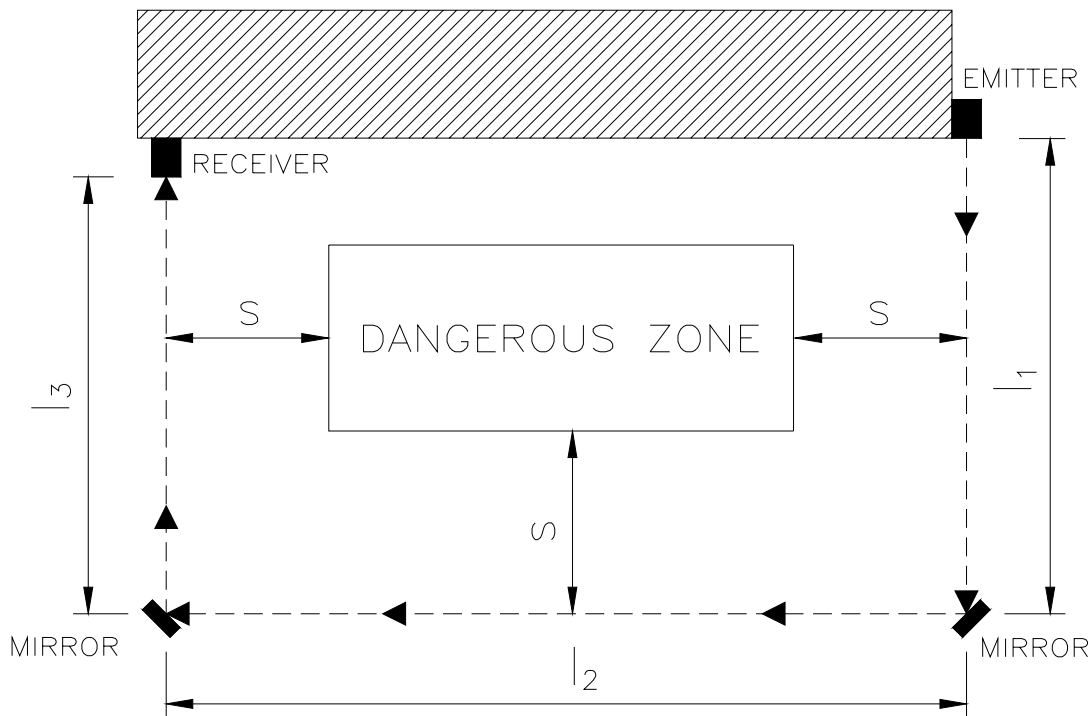

Figure 7 – Deflecting mirrors

When using deflecting mirrors, comply with the following rules:

- Position the mirrors so as to comply with the minimum safety distance S (Figure 7) on each side of access to the dangerous area.
- The working distance (working range) is given by the sum of the lengths of all the access sides to the protected area. (Note that the maximum working range between the Emitter and Receiver is reduced by 15% for each mirror used).
- In the installation phase, take care to avoid twisting along the longitudinal axis of the mirror.
- Standing close to and in axis the Receiver, check that the **entire shape** of the Emitter is visible on the first mirror.
- It is advisable not to use more than three deflecting mirrors.

Distance from reflective surfaces

⚠ The presence of reflective surfaces close to the light curtain may cause occasional reflections that prevent sensing. Referring to Figure 8, object A is not detected due to surface S that, reflecting the beam, closes the optical path between the Emitter and Receiver. Therefore, a minimum distance d must be maintained between any reflecting surfaces and the guarded area. The minimum distance d must be calculated according to the distance l between the Emitter and Receiver and taking into account that the angle of projection and reception is 4° .

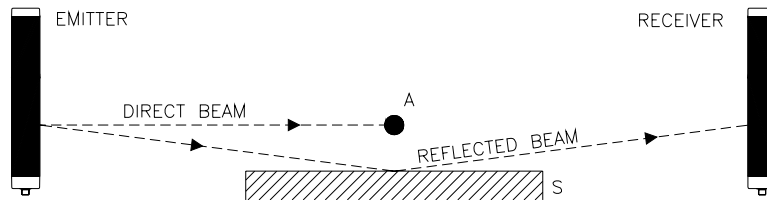

Figure 8 - Reflective surfaces

The distance d to be kept as the distance l between Emitter and Receiver varies is shown in Picture 9.

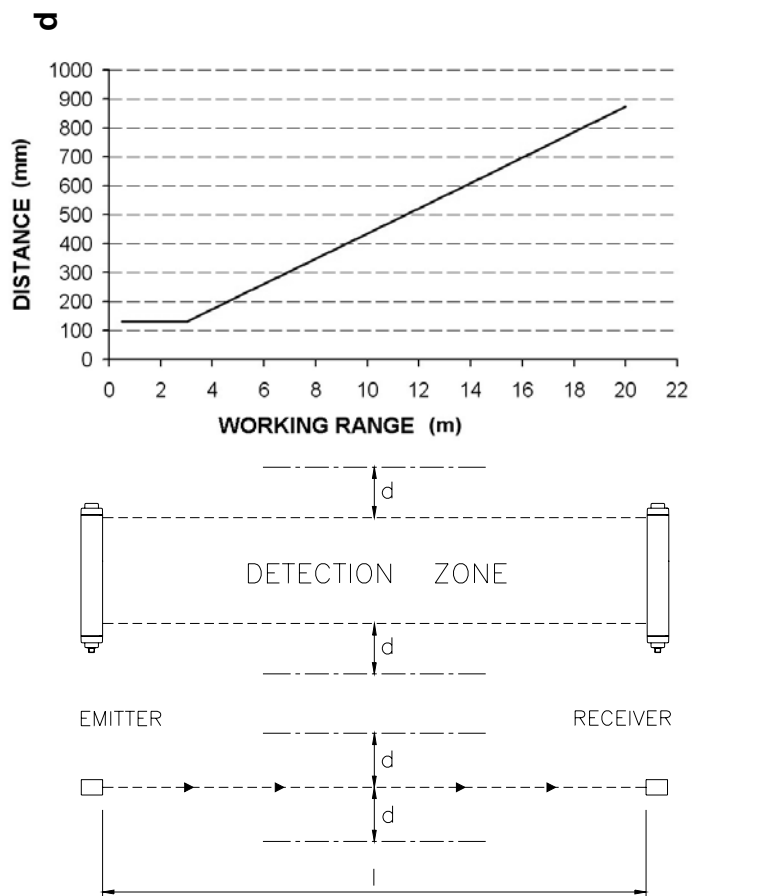

Figure 9 - Minimum distance d

After installing the system, check for any reflective surface that intercept the beams, first of all at the centre and then close to the Emitter and Receiver. During this procedure, the red led on the Receiver must never switch off.

Mechanical assembly and optical alignment

The Emitter and Receiver must be installed facing each other, at a distance equal to or less than that indicated in the technical data. Using the provided **inserts and fastening brackets**, place the Emitter and Receiver so that they are aligned and parallel to each other, and with the connectors facing the same side.

According to the dimensions and shape of the support to be used to install the Emitter and Receiver, these must be mounted with the fastening inserts to the rear or inserting these in the side spline (Figure 10).

Perfect alignment of the Emitter and Receiver is essential for efficient functioning of the light curtain; this operation is facilitated observing the indicator leds of the Emitter and of Receiver.

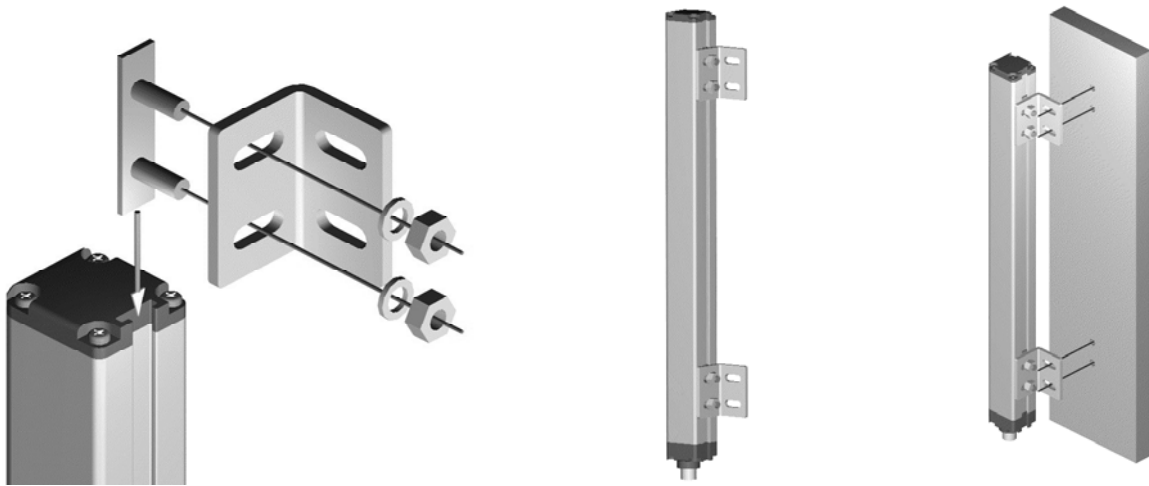

Figure 10 – Mechanical assembly

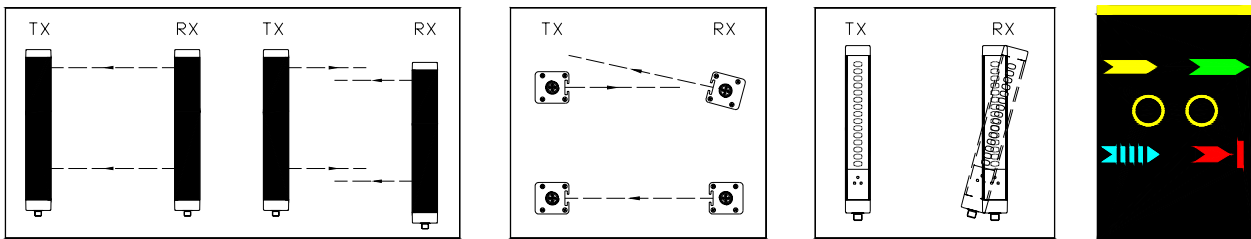

Figure 11 – Optical alignment

- Position the optical axis of the first and last beam of the Emitter on the same axis as that of the corresponding beams on the Receiver.
- Move the Emitter in order to locate the area within which the green led on the Receiver remains on, then position the first beam of the Emitter (that close to the indicator led) at the centre of this area.
- Using this beam as pivot, with minor movements of the opposite end, establish the free protected area condition which, in this situation, will be indicated by lighting up of the green led on the Receiver.
- Lock the Emitter and the Receiver in place.

During these operations it may be useful to check the presence of the **blue led weak signal (only for 14mm and H models)** on the Receiver display. Upon completion of alignment, this LED must be off.

English

➔ If the Emitter and Receiver are installed in areas subject to strong vibrations, **vibration-damping supports must be used** (for the order code, see the ACCESSORIES/SPARES paragraph) so as not to impair operation of the circuits.

Vertical positioning of the light curtain



Models with 14, 20mm resolution

These models are suitable for fingers detection.



Models with 30, 40mm resolution

These models are suitable for hand detection.

The minimum safety distance S is calculated according to the following formula:

$$S = 2000 (t_1 + t_2) + 8(D-14)$$

(D =resolution)

This formula is valid for distances S between 100 and 500 mm. If, according to the calculation, S exceeds 500 mm, the distance can be reduced down to a minimum of 500 mm using the following formula:

$$S = 1600 (t_1 + t_2) + 8(D-14)$$

If, in view of the particular configuration of the machine, the dangerous zone can be reached from above, the highest beam of the light curtain must be at a height H (from resting surface G) whose value is determined by using the *ISO 13855 Standard*.

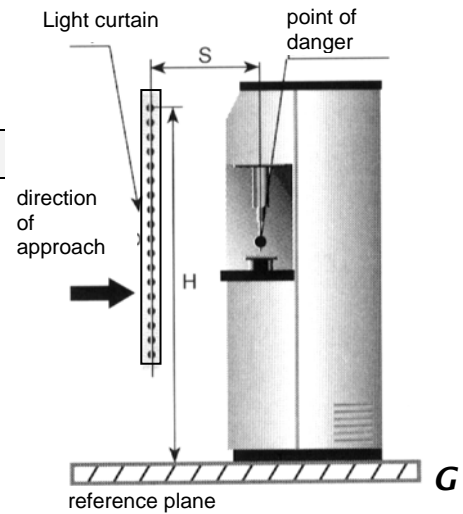

Figure 12 -
Vertical positioning
14mm, 20mm, 30mm, 40mm



Models with 50, 90mm resolution

These models are suitable for detecting the arm or the leg and must not be used to detect fingers or hands.

The minimum safety distance S is determined according to the following formula:

$$S = 1600 (t_1 + t_2) + 850$$

➔ In every case the height H of the highest beam from resting surface G must not be smaller than 900 mm, while the height of the lowest beam P must not be bigger than 300 mm (*ISO 13855 Standard*).

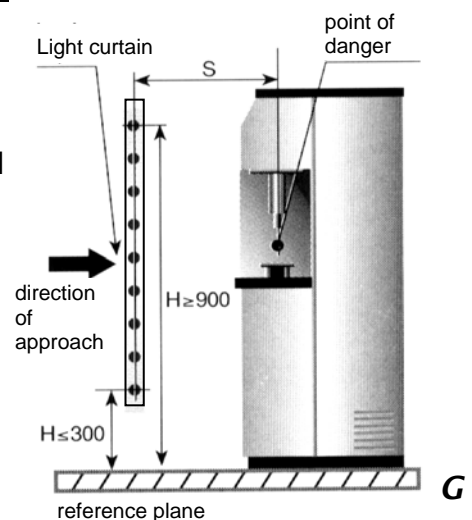

Figure 13 - 50mm, 90mm



Multibeam Models

These models are suitable for whole body detection and must not be used to detect arms or legs.

The minimum safety distance S is determined according to the following formula:

$$S = 1600 (t_1 + t_2) + 850$$

The recommend height H from the reference surface G (ground) is as follows (ISO 13855 Standard) :

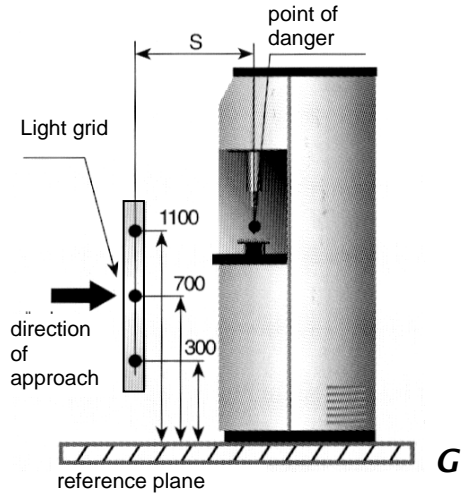

Figure 14 - Multibeam

MODEL	BEAMS	Recommended height H (mm)
EOS4 2B	2	400 - 900
EOS4 3B	3	300 - 700 - 1100
EOS4 4B	4	300 - 600 - 900 - 1200

Table 3 - Height H of Multibeam models

Horizontal positioning of the light curtain

When the direction of approach of the body is parallel to the plane of the protected area, the light curtain must be positioned so that the distance between the far end of the dangerous area and the outermost beam is equal to or greater than the minimum safety distance S calculated as follows:

$$S = 1600(t_1 + t_2) + 1200 - 0.4H$$

where H is the height of the protected surface from the machine reference plane;

$$H = 15(D-50)$$

(D =resolution)

In this case, H must always be less than of 1m (ISO 13855 Standard).

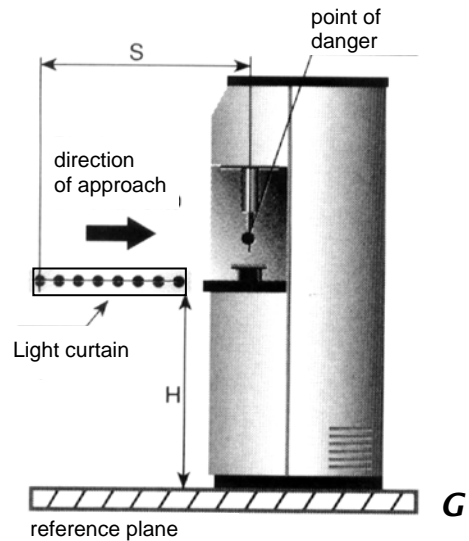



Figure 15 - Horizontal positioning

Electrical connections

WARNINGS

Before making electrical connections, make sure that the mains voltage matches the one indicated in the technical data.

 The Emitter and Receiver must be powered at a $24\text{Vdc} \pm 20\%$ (PELV, in compliance with the standard EN 60204-1 (Chapter 6.4)).

The electrical connections must be made according to the wiring diagrams provided in this manual.

In particular, do not connect other devices to the connectors of the Emitter and Receiver.

To guarantee reliable operation using a diode bridge power supply unit, its output capacity must be at least $2000\mu\text{F}$ for each A absorbed.

Layout of the connectors on MASTER/SLAVE light curtain

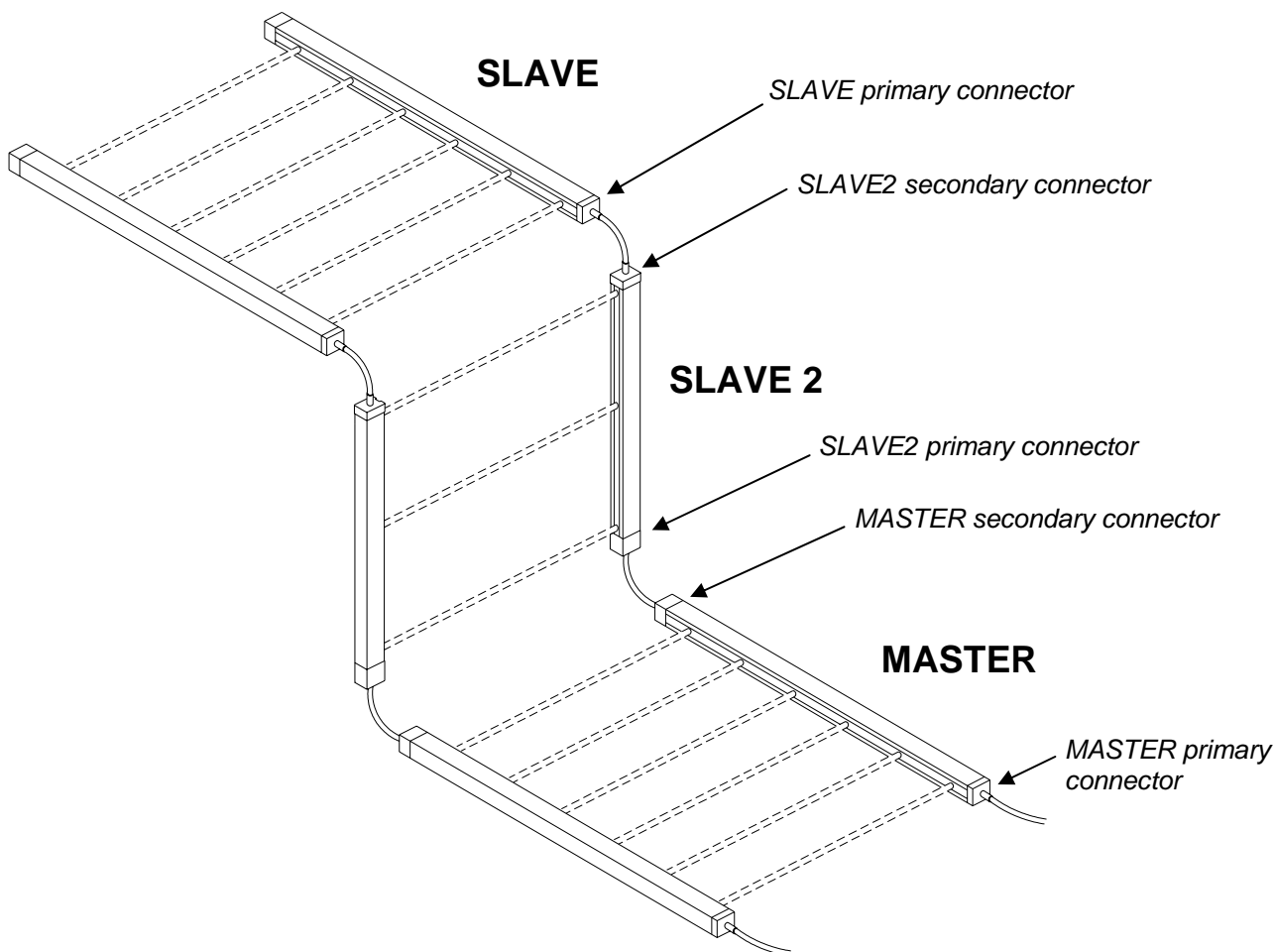
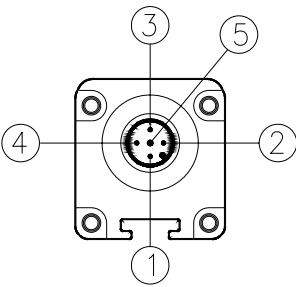

Figure 16 - Connector layout

Emitter connections

**EOS4A - EOS4X (with integrated control functions) - EOS4XM (MASTER models)
M12 5-pin primary connectors.**



PIN	COLOUR	NAME	TYPE	DESCRIPTION
1	Brown	24VDC	INPUT	24VDC power supply
2	White	RANGE0		Light curtain configuration complying with the EN61131-2 standard (ref. Table 5)
3	Blue	0VDC		0VDC power supply
4	Black	RANGE1		Light curtain configuration complying with the EN61131-2 standard (ref. Table 5)
5	Grey	FE		Ground connection

Table 4 - M12, 5 pin
Master/Standard/with integrated control functions TX

RANGE AND TEST SELECTION - (PRIMARY CONNECTOR M12, 5 PIN)		
PIN 4	PIN 2	MEANING
24V	0V	Selection HIGH Range
0V	24V	Selection LOW Range
0V	0V	Emitter in TEST
24V	24V	Selection error

Table 5 – Range and TEST selection

➔ For correct operation of the light curtain, pins 2 and 4 of the Emitter must be connected as indicated in Table 5.

EOS4XS - EOS4XS2 (SLAVE/SLAVE2 models) - M12, 5-pin primary connector.

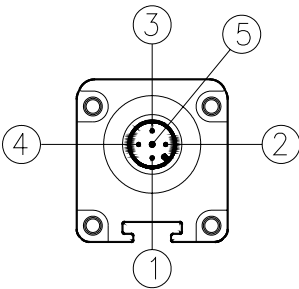

PIN	COLOUR	NAME	DESCRIPTION
1	Brown	24VDC	24VDC power supply
2	White	LINE_A	Communication MASTER-SLAVE
3	Blue	0VDC	0VDC power supply
4	Black	LINE_B	Communication MASTER-SLAVE
5	Grey	FE	Ground connection

Table 6 - M12, 5-pin Primary Slave TX

**EOS4XM (MASTER models) – M12, 5-pin secondary connector.
EOS4XS2 (SLAVE2 models) – M12, 5-pin secondary connector.**

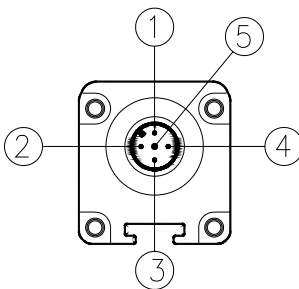

PIN	COLOUR	NAME	DESCRIPTION
1	Brown	24VDC	24VDC power supply
2	White	LINE_A	Communication MASTER-SLAVE
3	Blue	0VDC	0VDC power supply
4	Black	LINE_B	Communication MASTER-SLAVE
5	Grey	FE	Ground connection

Table 7 - M12, 5-pin Secondary TX

Receiver connections

EOS4A models - M12, 5-pin connector.

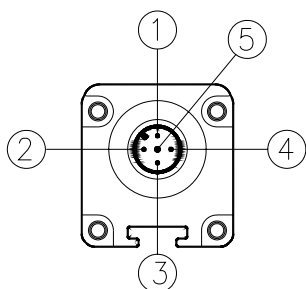

PIN	COLOUR	NAME	TYPE	DESCRIPTION	OPERATION
1	Brown	24VDC	-	24VDC power supply	-
2	White	OSSD1	OUT	Static safety output 1	PNP active high
3	Blue	0VDC	-	0VDC power supply	-
4	Black	OSSD2	OUT	Static safety output 2	PNP active high
5	Grey	FE	-	Ground connection	-

Table 8 - M12, 5 pins Primary RX

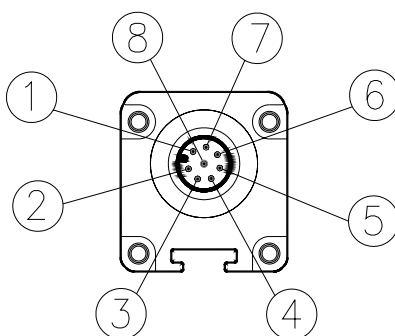

EOS4X (models with integrated control functions) - M12, 8-pin connector.
EOS4XM (MASTER models) - M12, 8-pin primary connector.

PIN	COLOUR	NAME	TYPE	DESCRIPTION	OPERATION
1	White	OSSD1	OUTPUT	Static safety output 1	PNP active high
2	Brown	24VDC	-	24VDC power supply	-
3	Green	OSSD2	OUTPUT	Static safety output 2	PNP active high
4	Yellow	K1_K2/RESTART	INPUT	Feedback from external contactors	Complying with the EN61131-2 standard (ref. Par. "Configuration and operating modes" page 19)
5	Grey	SEL_A	INPUT	Light curtain configuration	
6	Pink	SEL_B	INPUT		
7	Blue	0VDC	-	0VDC power supply	-
8	Red	FE	-	Ground connection	-

Table 9 - M12, 8 pins RX

EOS4XS - EOS4XS2 (SLAVE/SLAVE2 models) - M12, 5-pin primary connectors.

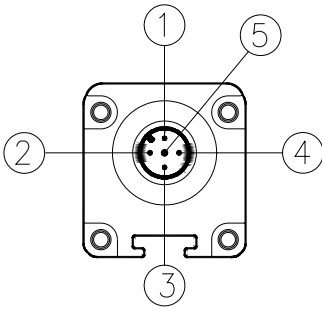

PIN	COLOUR	NAME	DESCRIPTION
1	<i>Brown</i>	24VDC	24VDC power supply
2	<i>White</i>	LINE_A	Communication MASTER-SLAVE
3	<i>Blue</i>	0VDC	0VDC power supply
4	<i>Black</i>	LINE_B	Communication MASTER-SLAVE
5	<i>Grey</i>	FE	Ground connection

Table 10 - M12, 5 pins Primary Slave RX

**EOS4XM (MASTER models) - M12, 5-pin Secondary Connector.
EOS4XS2 (SLAVE2 models) - M12, 5-pin Secondary Connector.**

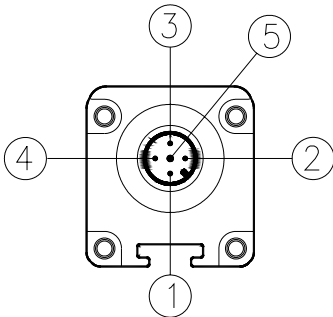

PIN	COLOUR	NAME	DESCRIPTION
1	<i>Brown</i>	24VDC	24VDC power supply
2	<i>White</i>	LINE_A	Communication MASTER-SLAVE
3	<i>Blue</i>	0VDC	0VDC power supply
4	<i>Black</i>	LINE_B	Communication MASTER-SLAVE
5	<i>Grey</i>	FE	Ground connection

Table 11 - M12, 5 pin Secondary RX

Warnings regarding connection cables

- For connections with a length of more than 50m, use cables having a cross-section of at least 1 mm².
- It is good practice to keep the power supply of the light curtain separate from that of other electric power equipment (electric motors, inverters, frequency variators) or other sources of disturbance.
- Connect the Emitter and Receiver to the ground outlet.
- The connection cables must follow a different route from that of other power cables.

Configuration and operating modes (Master Models / With integrated control functions)

The operating mode of the EOS4 light curtain is set by making suitable connections on the M12 – 8-pin connector of the Receiver (Table 12).

CONNECTIONS			OPERATING MODE
K1_K2/restart (PIN 4) connected to : 24VDC	SEL_A (PIN 5) connected to : 24VDC	SEL_B (PIN 6) connected to : 0VDC	AUTOMATIC (Figure 17)
K1_K2/restart (PIN 4) connected to : 24VDC <i>(via set of NC contacts of K1K2)</i>	SEL_A (PIN 5) connected to : 24VDC	SEL_B (PIN 6) connected to : 0VDC	AUTOMATIC with control K1K2 (Figure 18)
K1_K2/restart (PIN 4) connected to : 24VDC <i>(via RESTART button)</i>	SEL_A (PIN 5) connected to : 0VDC	SEL_B (PIN 6) connected to : 24VDC	MANUAL (Figure 19)
K1_K2/restart (PIN 4) connected to : 24VDC <i>(via RESTART button and set of NC contacts of K1K2)</i>	SEL_A (PIN 5) connected to : 0VDC	SEL_B (PIN 6) connected to : 24VDC	MANUAL with control K1K2 (Figure 20)

Table 12 –Setting of manual/automatic mode

Automatic operation

 If the EOS4 light curtain is used in AUTOMATIC mode, it will not be equipped with a start/restart interlock circuit. In most applications, this safety function is compulsory. Carefully assess the risks analysis of your own application.

In this operating mode, the OSSD1 and OSSD2 safety outputs follow the status of the light curtain :

- with guarded area free, the outputs are ON.
- with guarded area occupied, they are OFF.

Manual operation



 Use in manual mode (start/restart interlock ON) is compulsory if the safety device controls an opening in order to protect a dangerous area and if a person, after passing through the opening, can remain in the dangerous area without being detected (use as 'trip device' according to IEC 61496). Failure to comply with this regulation may result in very serious hazards for the persons exposed.

In this operating mode, the safety outputs OSSD1 and OSSD2 are activated in a condition of free protected area and after having received the RESTART signal via push-button or a specific command on the K1K2/RESTART input).

Following occupation of the protected area, the outputs will be disabled. For re-activation, repeat the sequence described above.



The RESTART command is active with transition **0Vdc -> 24Vdc -> 0Vdc**.

The duration of the command must be within **100ms and 5s**.

-  The Restart command must be installed outside the danger area in a position where the danger area and the entire work area concerned are clearly visible.
-  It must not be possible to reach the control from inside the danger area.

Connection of external contactors K1 and K2

In both operating modes, it is possible to activate control of the external contactors K1/K2 (series of contacts). If this control is to be used, it is necessary to connect pin 4 of the M12 8-pin connector of the Receiver with the power supply (24VDC) via a set of NC contacts (feedback) of the external contactors.

-  In the case of manual operation, the RESTART button in series with the NC contacts (feedback) of the external contactors K1/K2 (Figure 20) must also be present.
-  If the application requires it, the response time of the external contactors must be verified by an additional device.

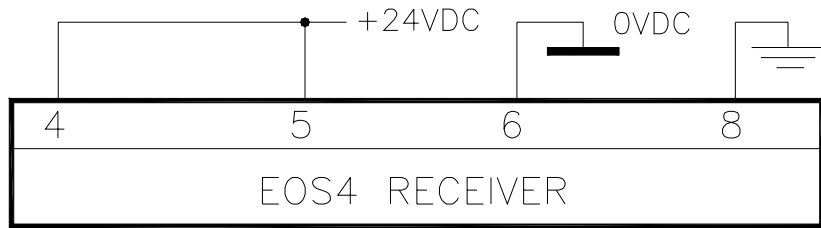

Figure 17 - Automatic

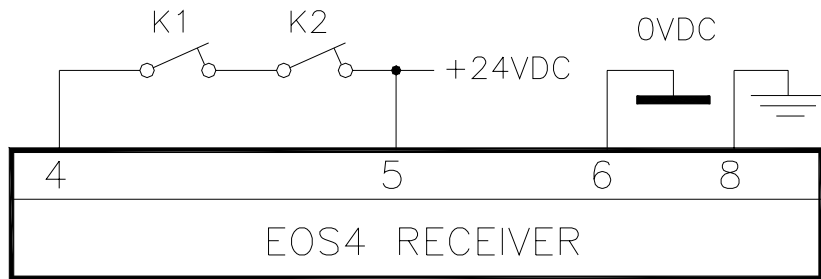

Figure 18 – Automatic with K1K2 feedback

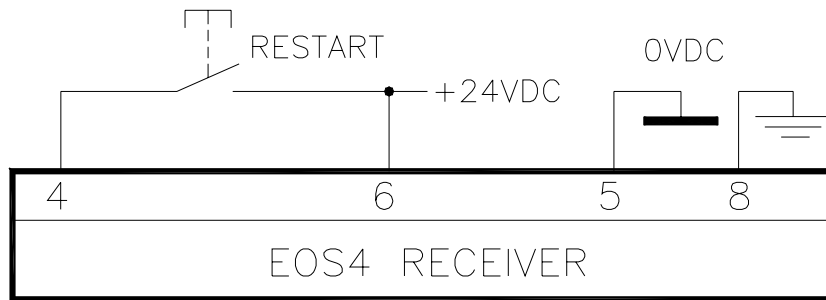

Figure 19 - Manual

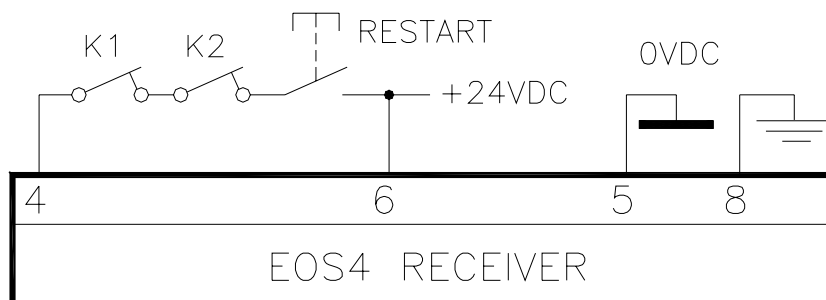

Figure 20 – Manual with K1K2 feedback

Examples of connection with REER safety modules

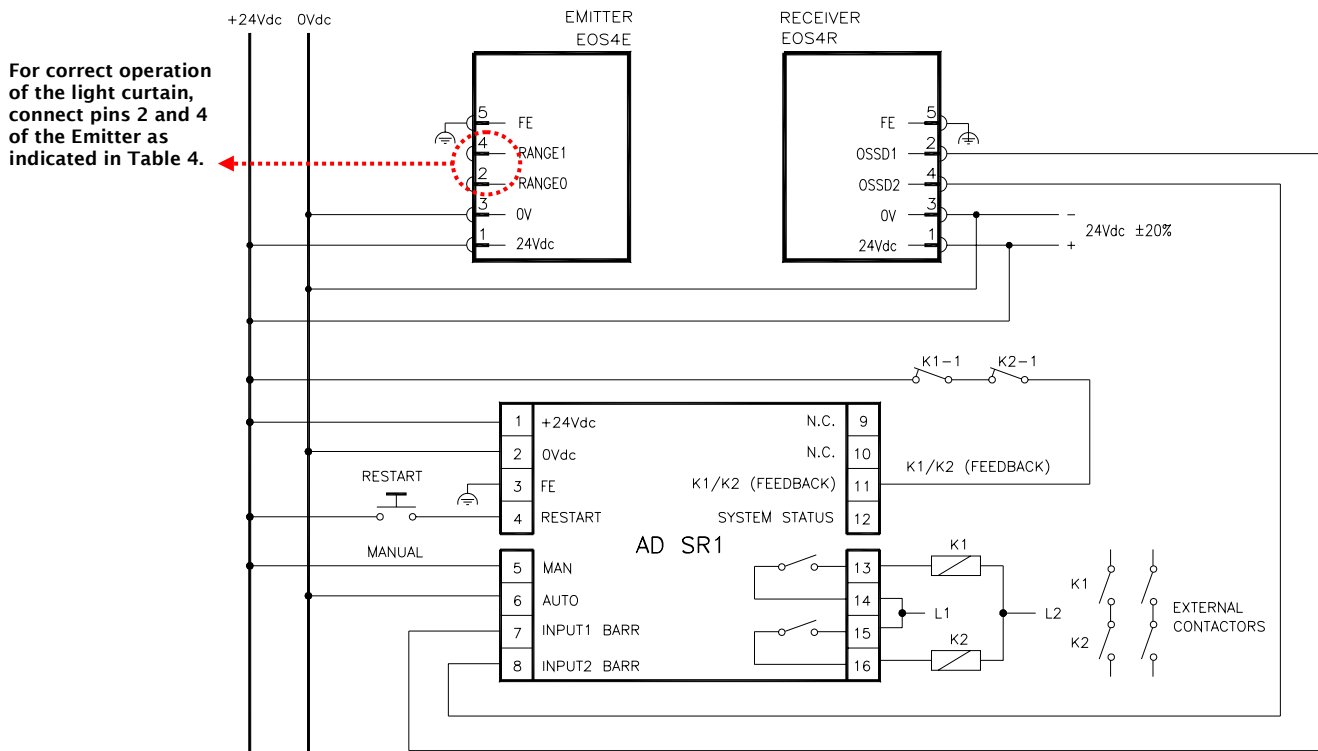

Figure 21 - EOS4 A: Manual operation with AD SR1 module

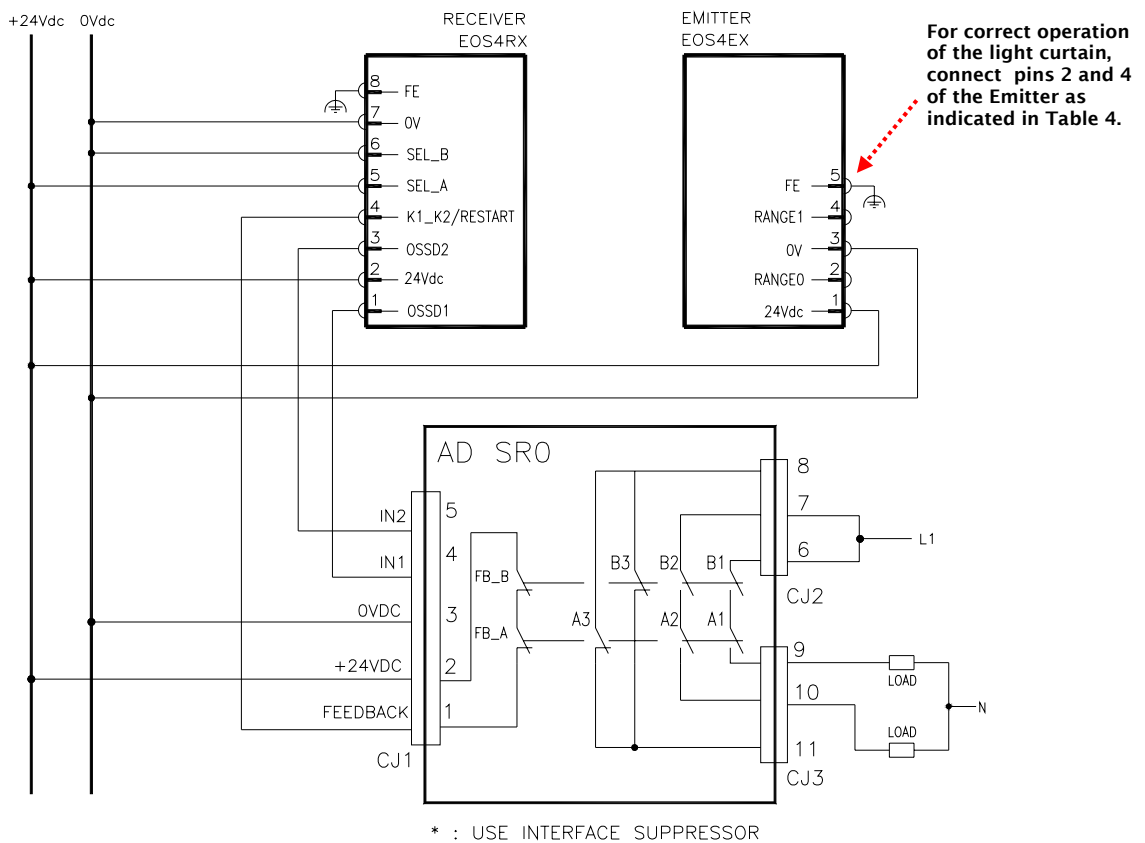
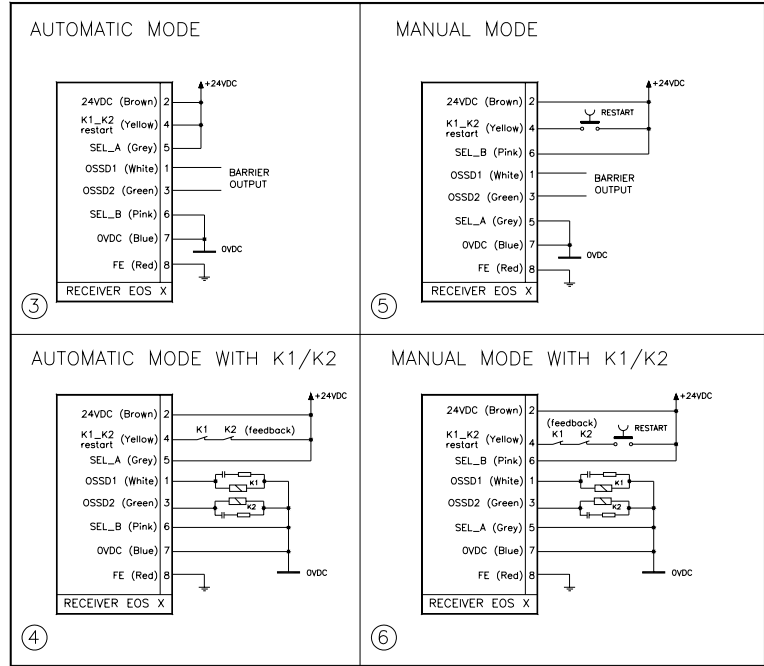
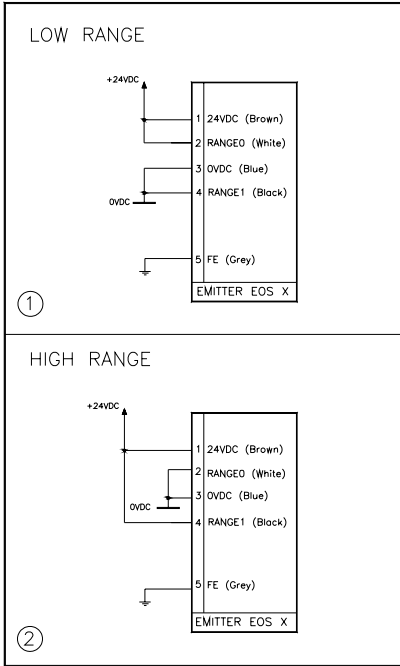

Figure 22 - EOS4 X: Automatic operation with AD SR0 module

English

EMITTER EOS X

RECEIVER EOS X



EOSX --> ADSR0

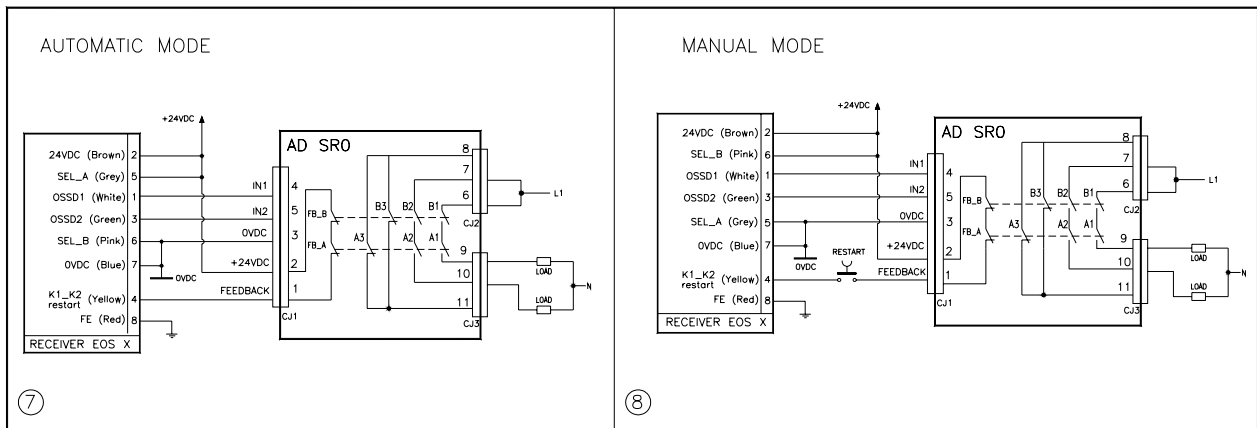

EOSX --> ADSROA

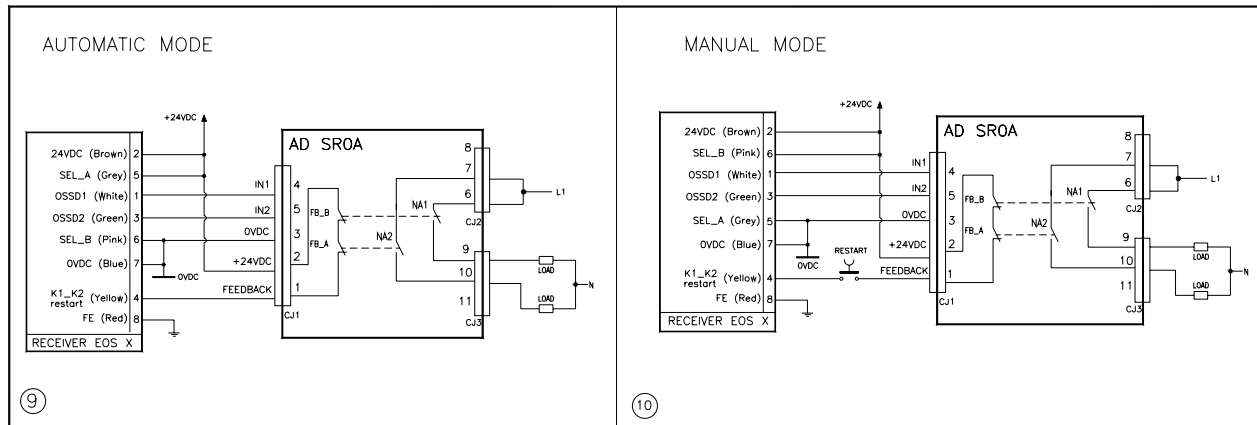
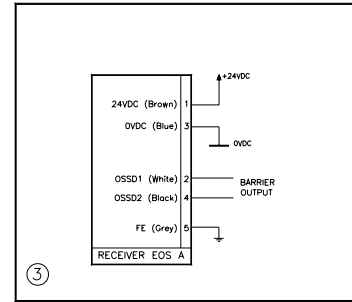
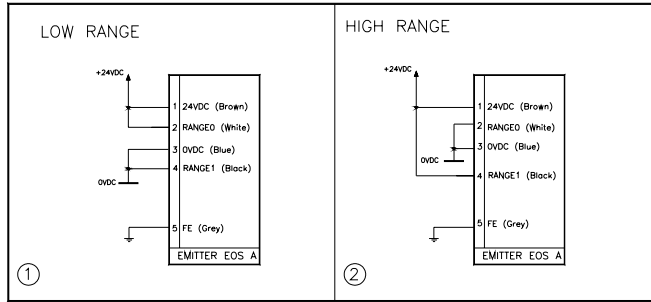

Figure 23 - EOS4 X: Connection examples

EMITTER EOS A

RECEIVER EOS A



EOS A --> ADSR1

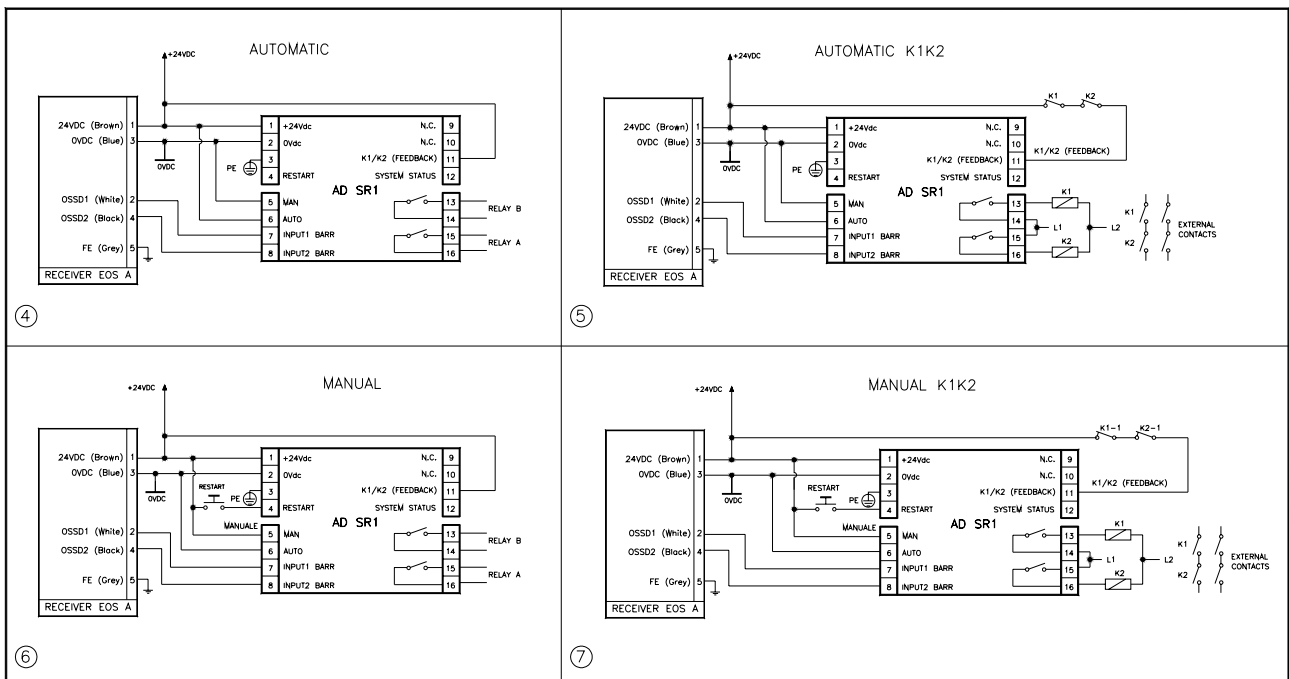

Figure 24 - EOS4 A: Connection examples

OPERATION AND TECHNICAL DATA

Light signals

The leds on the Emitter and Receiver light up according to system operating conditions. Refer to the tables below to identify the various indications (ref. Figure 25).

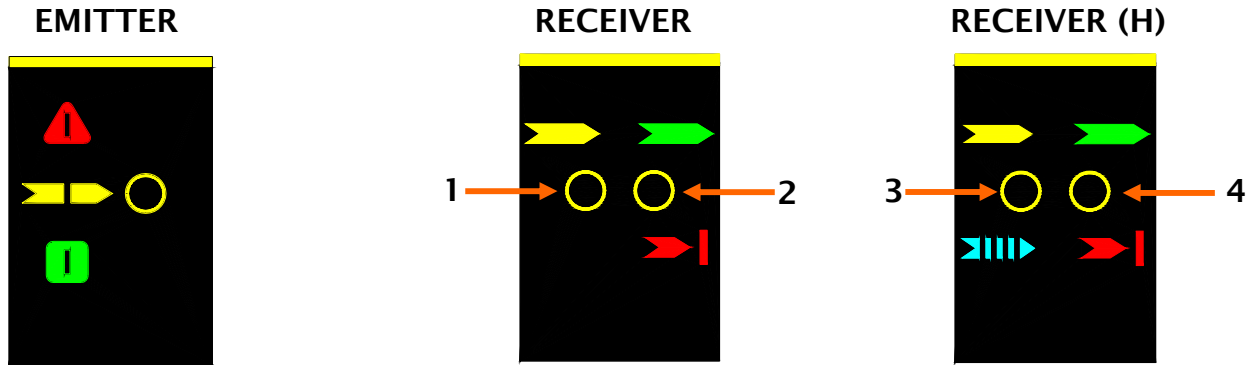

Figure 25 - Light signals

Emitter light signals

MEANING	THREE-COLOUR LED (Red/Green/Orange)
System power-on. Initial TEST.	RED
FAIL condition (Table 19)	RED BLINKING ²
TEST condition	ORANGE
Normal operating condition	GREEN ³

Table 13 – TX light signals

Receiver light signals

MEANING	LED	
	TWO-COLOUR (Red/Green) (2)	YELLOW (1)
System power-on. Initial TEST.	RED	ON
BREAK condition (A)	RED	OFF
GUARD condition (C)	GREEN	OFF
BREAK_K condition (D)	YELLOW BLINKING	YELLOW BLINKING
FAIL condition (Table 19)	RED BLINKING ²	OFF

Table 14 – RX light signals EOS4 / EOS4 Slave

MEANING	LED	
	TWO-COLOUR (Red/Green) (2)	YELLOW (1)
System power-on. Initial TEST	RED	ON
BREAK condition (A)	RED	OFF
CLEAR condition (B)	OFF	ON
GUARD condition (C)	GREEN	OFF
BREAK_K condition (D)	YELLOW BLINKING	YELLOW BLINKING
FAIL condition (Table 19)	RED BLINKING ²	OFF

Table 15 – RX light signals EOS4 (With integrated control functions)

² The type of fault is identified by the number of flashes (see *Troubleshooting* chapter)

³ Double blinking (at power-on) of the GREEN led indicates that high range has been selected.

MEANING	TWO-COLOUR (Red/Green) (4)	TWO-COLOUR (Yellow/Blue) (3)
System power-on. Initial TEST	RED	YELLOW
BREAK condition (A)	RED	OFF
CLEAR condition (B)	OFF	YELLOW
GUARD condition (C)	GREEN	OFF
BREAK_K condition (D)	YELLOW BLINKING	YELLOW BLINKING
FAIL condition (Table 19)	RED BLINKING ⁴	OFF
GUARD condition with weak signal	GREEN	BLUE
CLEAR condition with weak signal	-	YELLOW /BLUE <i>alternating</i>
BREAK condition with weak signal	RED	BLUE
BREAK_K condition with weak signal	YELLOW BLINKING	YELLOW

Table 16 - RX light signals **EOS4 14mm and H (20m)**

MEANING	LED	
	TWO-COLOUR (Red/Green) (2)	YELLOW (1)
System power-on. Initial TEST	RED	ON
BREAK condition (A)	RED	OFF
CLEAR condition (B)	OFF	ON
GUARD condition (C)	GREEN	OFF
BREAK_K condition (D)	YELLOW BLINKING	YELLOW BLINKING
FAIL condition (Table 19)	RED BLINKING ⁴	OFF
MASTER : Light curtain free; SLAVE : Light curtain(s) occupied	RED	Blinking

Table 17 – RX light signals **EOS4 (Master)**

- (A) Light curtain occupied - outputs disabled
- (B) Light curtain free - outputs disabled - awaiting restart
- (C) Light curtain free - outputs enabled
- (D) Light curtain free - outputs disabled - awaiting feedback K1_K2 OK

TEST function

The test function simulates the occupation of the protected area, allowing checking by an external supervisor (e.g. PLC, control module, etc.) of the correct operation of the entire system. Via an automatic fault detection system, the EOS4 light curtain is able to verify occurrence of a fault independently within the response time (declared for each model).

This fault detection system is always active and does not require any external intervention. The TEST command is available in the case in which the user wishes to check the devices connected downstream of the light curtain (without physically intervening inside the guarded area). This command interrupts emission of the beams on the emitter and makes it possible to switch the OSSD from ON to OFF status as long as the command is active.

➔ The minimum duration of the TEST command must be at least 4 msec.

Status of the outputs

On the Receiver of the EOS4 there are two PNP static outputs whose status depends on the condition of the protected area.

- The maximum permissible load for each output is 400mA@24VDC, corresponding to a resistive load of 60Ω.
- The maximum OFF-state voltage is < 0,5VDC.
- The maximum output current in OFF-state (leakage current) is <2mA.
- The maximum load capacity corresponds to 0.82µF@24VDC.

⁴ The type of fault is identified by the number of flashes (see *Troubleshooting* chapter)

The meaning of the status of the outputs is illustrated in the table below. Any short-circuit between the outputs or between the outputs and 24VDC or 0VDC power supply is detected by the light curtain.

SIGNAL NAME	CONDITION	MEANING
OSSD1	24VDC	Light curtain free condition.
OSSD2		
OSSD1	0VDC	Light curtain occupied or fault detected condition
OSSD2		

Table 18 - Status of the outputs

In free protected area conditions, the Receiver provides a voltage of 24VDC on both outputs. Therefore, the established load must be connected between the output terminals and the 0VDC (Figure 26).

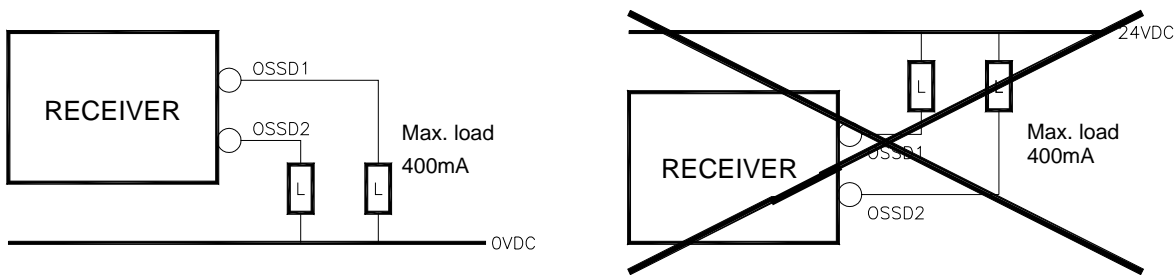

Figure 26 – Correct load connection on the outputs

Technical specifications

TECHNICAL SPECIFICATIONS EOS4 LIGHT CURTAINS		
Protected height	mm	160 - 1510
Resolutions	mm	14 - 20 - 30 - 40 - 50 - 90
No. of beams (Multibeam Models)		2/3/4 beams
Working range (selectable)	m	14mm Models 0 ÷ 3 (low) / 1 ÷ 6 (high)
		30-40-50-90-Multibeam Models 0 ÷ 4 (low) / 0 ÷ 12 (high)
		20-30-40-50-90-Multibeam Models H 0 ÷ 10 (low) / 3 ÷ 20 (high)
Safety outputs		2 PNP - 400mA @ 24VDC
Response time	ms	2,5 ÷ 20 (see models tables)
Power supply	VDC	24 ± 20%
Connections		M12 (5/8 pin) connectors
Max. length of connections	m	100 (50 between Master and Slave)
Operating temperature	°C	-10 ÷ 55°C
Protection rating		IP 65 - IP 67
Section dimensions	mm ²	28 x 30
Max. consumption	W	1 (Emitter) 2 (Receiver)
Light curtain lifetime		20 years
Safety level	Type 4	IEC 61496-1:2004 IEC 61496-2:2006
	SIL 3	IEC 61508:1998
	SILCL 3	IEC 62061:2005
	PL e - Category 4	ISO 13849-1:2006

14 mm Resolution Models		151	301	451	601	751	901	1051	1201	1351	1501
Number of beams		15	30	45	60	75	90	105	120	135	150
Response time	ms	4	5,5	7,5	9	11	13	14,5	16,5	18	20
Response time (Master + 1 slave)	ms	$t_{tot} = [0,06 * (N_{rslave1} + N_{rmaster}) + 0,9836] * 2$									
Response time (Master + 2 slaves)	ms	$t_{tot} = [0,06 * (N_{rslave1} + N_{rslave2} + N_{rmaster}) + 1,0336] * 2$									
Protected height	mm	160	310	460	610	760	910	1060	1210	1360	1510
Curtain tot. height	mm	236,5	386,5	536,5	686,5	836,5	986,5	1136,5	1286,5	1436,5	1586,5
PFHd *		1,03E-08	1,27E-08	1,52E-08	1,75E-08	2,00E-08	2,24E-08	2,49E-08	2,73E-08	2,98E-08	3,22E-08
DCavg #		95,4%	94,9%	94,5%	94,1%	93,8%	93,6%	93,3%	93,1%	92,9%	92,8%
MTTFd #	years	100									
CCF #		80%									

30 mm Resolution Models		153	303	453	603	753	903	1053	1203	1353	1503
Number of beams		8	16	23	31	38	46	53	61	68	76
Response time	ms	4	5,5	7,5	9	10,5	12,5	14	15,5	17	19
Response time (Master + 1 slave)	ms	$t_{tot} = [0,11 * (N_{rslave1} + N_{rmaster}) + 0,9376] * 2$									
Response time (Master + 2 slaves)	ms	$t_{tot} = [0,11 * (N_{rslave1} + N_{rslave2} + N_{rmaster}) + 1,0508] * 2$									
Protected height	mm	160	310	460	610	760	910	1060	1210	1360	1510
Curtain tot. height	mm	236.5	386.5	536.5	686.5	836.5	986.5	1136.5	1286.5	1436.5	1586.5
PFHd *		7,10E-09	8,21E-09	9,47E-09	1,06E-08	1,19E-08	1,30E-08	1,42E-08	1,53E-08	1,66E-08	1,77E-08
DCavg #		96,7%	97,0%	97,2%	97,3%	97,4%	97,5%	97,6%	97,6%	97,7%	97,7%
MTTFd #	years	100									
CCF #		80%									

40 mm Resolution Models		154	304	454	604	754	904	1054	1204	1354	1504
Number of beams		6	11	16	21	26	31	36	41	46	51
Response time	ms	3,5	4,5	5,5	7	8	9	10	11	12,5	13,5
Response time (Master + 1 slave)	ms	$t_{tot} = [0,11 * (N_{rslave1} + N_{rmaster}) + 0,9376] * 2$									
Response time (Master + 2 slaves)	ms	$t_{tot} = [0,11 * (N_{rslave1} + N_{rslave2} + N_{rmaster}) + 1,0508] * 2$									
Protected height	mm	160	310	460	610	760	910	1060	1210	1360	1510
Curtain tot. height	mm	236.5	386.5	536.5	686.5	836.5	986.5	1136.5	1286.5	1436.5	1586.5
PFHd *		6,84E-09	7,77E-09	8,58E-09	9,51E-09	1,03E-08	1,12E-08	1,21E-08	1,30E-08	1,38E-08	1,47E-08
DCavg #		96,5%	96,7%	97,0%	97,1%	97,2%	97,3%	97,4%	97,4%	97,5%	97,5%
MTTFd #	years	100									
CCF #		80%									

50 mm Resolution Models		155	305	455	605	755	905	1055	1205	1355	1505
Number of beams		4	8	12	16	20	24	28	32	36	40
Response time	ms	3	4	4,5	5,5	6,5	7,5	8,5	9	10	11
Response time (Master + 1 slave)	ms	$t_{tot} = [0,11 * (N_{rslave1} + N_{rmaster}) + 0,9376] * 2$									
Response time (Master + 2 slaves)	ms	$t_{tot} = [0,11 * (N_{rslave1} + N_{rslave2} + N_{rmaster}) + 1,0508] * 2$									
Protected height	mm	160	310	460	610	760	910	1060	1210	1360	1510
Curtain tot. height	mm	236.5	386.5	536.5	686.5	836.5	986.5	1136.5	1286.5	1436.5	1586.5
PFHd *		6,53E-09	7,16E-09	7,85E-09	8,48E-09	9,17E-09	9,80E-09	1,05E-08	1,11E-08	1,18E-08	1,24E-08
DCavg #		96,5%	96,8%	96,9%	97,1%	97,2%	97,3%	97,4%	97,5%	97,5%	97,6%
MTTFd #	years	100									
CCF #		80%									

* IEC 61508
ISO 13849-1

90 mm Resolution Models	309	459	609	759	909	1059	1209	1359	1509
Number of beams	4	6	8	10	12	14	16	18	20
Response time (EOS models) ms	3	3,5	4	4,5	5	5,5	5,5	6	6,5
Response time (Master +1 slave) ms	$t_{tot} = [0,11 * (Nr_{slave1} + Nr_{master}) + 0,9376] * 2$								
Response time (Master + 2 slaves) ms	$t_{tot} = [0,11 * (Nr_{slave1} + Nr_{slave2} + Nr_{master}) + 1,0508] * 2$								
Protected height mm	310	460	610	760	910	1060	1210	1360	1510
Curtain tot. height mm	386.5	536.5	686.5	836.5	986.5	1136.5	1286.5	1436.5	1586.5
PFHd *	6,79E-09	7,34E-09	7,78E-09	8,33E-09	8,77E-09	9,32E-09	9,76E-09	1,03E-08	1,07E-08
DCavg #	96,5%	96,6%	96,7%	96,8%	96,9%	96,9%	97,0%	97,1%	97,1%
MTTFd # years	100								
CCF #	80%								

Multibeam Models	2B	3B	4B
Number of beams	2	3	4
Distance between the beams mm	500	400	300
Response time ms	2,5	3	3
Response time (Master +1 slave) ms	$t_{tot} = [0,11 * (Nr_{slave1} + Nr_{master}) + 0,9376] * 2$		
Response time (Master + 2 slaves) ms	$t_{tot} = [0,11 * (Nr_{slave1} + Nr_{slave2} + Nr_{master}) + 1,0508] * 2$		
Curtain tot. height mm	677	977	1077
PFHd *	6,89E-09	7,55E-09	8,21E-09
DCavg #	96,2%	96,2%	96,1%
MTTFd # years	100		
CCF #	80%		

* IEC 61508

ISO 13849-1

20m MODELS

20 mm H Resolution Models	152	302	452	602	752	902	1052	1202	1352	1502
Number of beams	15	30	45	60	75	90	105	120	135	150
Response time	ms	4	5,5	7,5	9	11	13	14,5	16,5	18
Response time (Master + 1 slave)	ms	$t_{tot} = [0,06 * (N_{rslave1} + N_{rmaster}) + 0,9836] * 2$								
Response time (Master + 2 slaves)	ms	$t_{tot} = [0,06 * (N_{rslave1} + N_{rslave2} + N_{rmaster}) + 1,0336] * 2$								
Protected height	mm	160	310	460	610	760	910	1060	1210	1360
Curtain tot. height	mm	236,5	386,5	536,5	686,5	836,5	986,5	1136,5	1286,5	1436,5
PFHd *		1,03E-08	1,27E-08	1,52E-08	1,75E-08	2,00E-08	2,24E-08	2,49E-08	2,73E-08	2,98E-08
DCavg		95,4%	94,9%	94,5%	94,1%	93,8%	93,6%	93,3%	93,1%	92,9%
MTTFd		100								
CCF		80%								

30 mm H Resolution Models	153	303	453	603	753	903	1053	1203	1353	1503
Number of beams	8	16	23	31	38	46	53	61	68	76
Response time	ms	3	4	5	6	6,5	7,5	8,5	9,5	10
Response time (Master + 1 slave)	ms	$t_{tot} = [0,06 * (N_{rslave1} + N_{rmaster}) + 0,9836] * 2$								
Response time (Master + 2 slaves)	ms	$t_{tot} = [0,06 * (N_{rslave1} + N_{rslave2} + N_{rmaster}) + 1,0336] * 2$								
Protected height	mm	160	310	460	610	760	910	1060	1210	1360
Curtain tot. height	mm	236.5	386.5	536.5	686.5	836.5	986.5	1136.5	1286.5	1436.5
PFHd *		9,13E-09	1,04E-08	1,16E-08	1,28E-08	1,41E-08	1,53E-08	1,66E-08	1,78E-08	1,91E-08
DCavg #		95,7%	95,4%	95,1%	94,9%	94,7%	94,5%	94,3%	94,1%	93,9%
MTTFd #	years	100								
CCF #		80%								

40 mm H Resolution Models	154	304	454	604	754	904	1054	1204	1354	1504
Number of beams	6	11	16	21	26	31	36	41	46	51
Response time	ms	3	3,5	4	4,5	5	6	6,5	7	7,5
Response time (Master + 1 slave)	ms	$t_{tot} = [0,06 * (N_{rslave1} + N_{rmaster}) + 0,9836] * 2$								
Response time (Master + 2 slaves)	ms	$t_{tot} = [0,06 * (N_{rslave1} + N_{rslave2} + N_{rmaster}) + 1,0336] * 2$								
Protected height	mm	160	310	460	610	760	910	1060	1210	1360
Curtain tot. height	mm	236.5	386.5	536.5	686.5	836.5	986.5	1136.5	1286.5	1436.5
PFHd *		8,84E-09	9,85E-09	1,06E-08	1,16E-08	1,23E-08	1,34E-08	1,41E-08	1,51E-08	1,59E-08
DCavg #		95,8%	95,5%	95,3%	95,1%	95,0%	94,8%	94,7%	94,5%	94,4%
MTTFd #	years	100								
CCF #		80%								

50 mm H Resolution Models	155	305	455	605	755	905	1055	1205	1355	1505
Number of beams	4	8	12	16	20	24	28	32	36	40
Response time	ms	2,5	3	3,5	4	4,5	5	5,5	6	6,5
Response time (Master + 1 slave)	ms	$t_{tot} = [0,06 * (N_{rslave1} + N_{rmaster}) + 0,9836] * 2$								
Response time (Master + 2 slaves)	ms	$t_{tot} = [0,06 * (N_{rslave1} + N_{rslave2} + N_{rmaster}) + 1,0336] * 2$								
Protected height	mm	160	310	460	610	760	910	1060	1210	1360
Curtain tot. height	mm	236.5	386.5	536.5	686.5	836.5	986.5	1136.5	1286.5	1436.5
PFHd *		8,50E-09	9,11E-09	9,82E-09	1,04E-08	1,11E-08	1,18E-08	1,25E-08	1,31E-08	1,38E-08
DCavg #		95,9%	95,7%	95,5%	95,4%	95,2%	95,1%	94,9%	94,8%	94,7%
MTTFd #	years	100								
CCF #		80%								

* IEC 61508
ISO 13849-1

90 mm H Resolution Models	309	459	609	759	909	1059	1209	1359	1509
Number of beams	4	6	8	10	12	14	16	18	20
Response time ms	2,5	3	3	3,5	3,5	3,5	4	4	4,5
Response time (Master +1 slave) ms	$t_{tot} = [0,06 * (N_{rslave1} + N_{rmaster}) + 0,9836] * 2$								
Response time (Master + 2 slaves) ms	$t_{tot} = [0,06 * (N_{rslave1} + N_{rslave2} + N_{rmaster}) + 1,0336] * 2$								
Protected height mm	310	460	610	760	910	1060	1210	1360	1510
Curtain tot. height mm	386.5	536.5	686.5	836.5	986.5	1136.5	1286.5	1436.5	1586.5
PFHd *	8,71E-09	9,23E-09	9,64E-09	1,02E-08	1,06E-08	1,11E-08	1,15E-08	1,20E-08	1,24E-08
DCavg #	95,8%	95,7%	95,6%	95,4%	95,3%	95,2%	95,1%	95,0%	95,0%
MTTFd # years	100								
CCF #	80%								

Multibeam H Models	2B	3B	4B
Number of beams	2	3	4
Distance between the beams mm	500	400	300
Response time ms	2,5	2,5	2,5
Response time (Master +1 slave) ms	$t_{tot} = [0,06 * (N_{rslave1} + N_{rmaster}) + 0,9836] * 2$		
Response time (Master + 2 slaves) ms	$t_{tot} = [0,06 * (N_{rslave1} + N_{rslave2} + N_{rmaster}) + 1,0336] * 2$		
Curtain tot. height mm	677	977	1077
PFHd *	9,15E-09	9,99E-09	1,08E-08
DCavg #	95,8%	95,6%	95,4%
MTTFd # years	100		
CCF #	80%		

* IEC 61508

ISO 13849-1

Dimensions

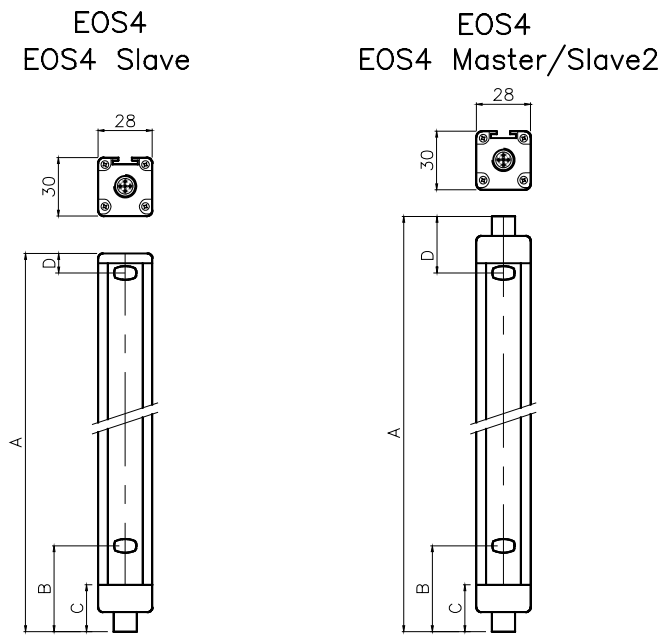

Figure 27 - Emitter and Receiver

Model	Height									
	150	300	450	600	750	900	1050	1200	1350	1500
A	213	363	513	663	813	963	1113	1263	1413	1563
A (Master/Slave)	236.5	386.5	536.5	686.5	836.5	986.5	1136.5	1286.5	1436.5	1586.5
B	61.5									
C	29.5									
D	11									
D (Master/Slave2) (With 2 connectors)	34.5									
Fastening	2 LE TYPE brackets with 2 inserts							3 LE TYPE brackets with 3 inserts		

Model	2B	3B	4B
A	653	953	1053
A (Master/Slave2)	677	977	1077
B	102		
C	29.5		
D	51		
D (Master/Slave2) (With 2 connectors)	75		
Fastening	2 LE TYPE brackets with 2 inserts		

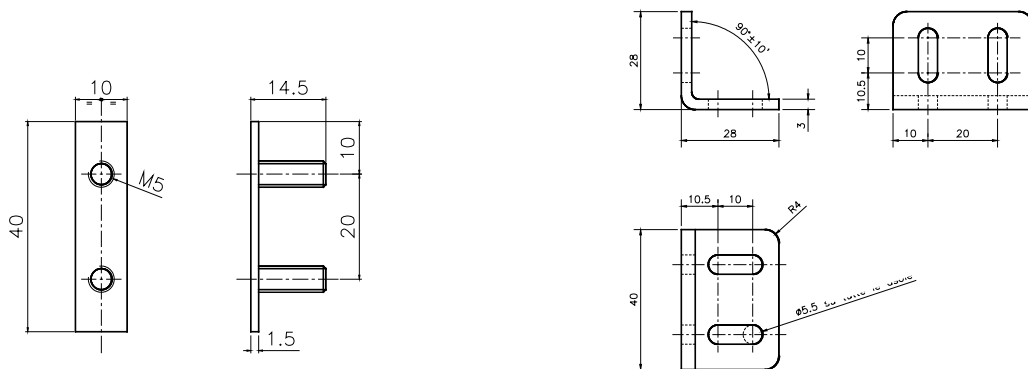

Figure 28 - FIE inserts and LE fastening brackets (provided)

CHECKOUTS AND MAINTENANCE

Checking of light curtain efficiency

⚠ Before each shift or at power-on, check the correct operation of the light curtain.

To do this, comply with the following procedure which uses a test object (available free of charge on request as accessory) to intercept the beams.

⚠ The correct test object must be used for the test, depending on light curtain resolution. Refer to the *Accessories/Spares chapter (page 35)* for the correct ordering code.

Referring to Figure 29:

- Introduce the test object in the protected area and move it slowly up and down, first at the centre and then close to both the Emitter and Receiver.
- For **Multibeam** models: using an opaque object, interrupt the beams one by one, first of all at the centre and then close to the Emitter and Receiver.
- Check that, in each phase of test object movement, the red led on the Receiver always remains ON.

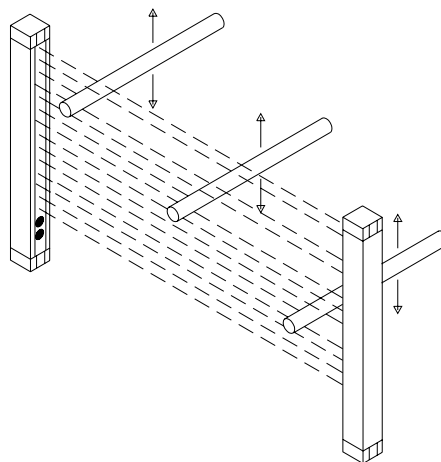

Figure 29 – Efficiency check

The EOS4 light curtain does not require any specific maintenance; however, it is good practice to clean the front protective surfaces of the mirrors of the Emitter and Receiver. Clean with a damp cloth; in very dusty environments, after cleaning the front surface, spray with an anti-stat product.

Never use abrasive or corrosive products, solvents or alcohol that could damage the part to be cleaned or wool cloths in order to prevent electrifying the front surface.

⚠ Even very fine scratching of the front plastic surfaces may increase the width of the beam emitted by the light curtain, thereby impairing its efficiency in the presence of reflecting side surfaces.

⚠ Therefore, during cleaning, it is essential to dedicate particular attention to the front window of the light curtain, in particular in environments characterised by abrasive powders (e.g. cement works etc).

Troubleshooting

The indications provided by the leds on the Emitter and Receiver make it possible to trace the cause of any system malfunction. As indicated in the "LIGHT SIGNALS" paragraph of this manual, in the case of a fault, the system switches to stop status and the leds of each unit indicate the type of fault that has occurred. (See the tables below). The numbers of the leds are referred to Figure 25.

EMITTER			
MEANING	THREE-COLOUR LED (Red/Green/Orange)		REMEDY
Irregular connection of pins 2 and 4	RED	2 consecutive flashes	- Check connections of pins 2 & 4.
Internal failure	RED	3/4 consecutive flashes	- Send to REER for repair.
Master and slave not compatible	RED	5 consecutive flashes	- Check model compatibility
Awaiting communication Master/Slave⁵	ORANGE	Flashing	- Check condition of the Master. - If in FAIL condition, check the type of fault. - If the fault persists, send the device to Reer laboratories for repair.
Loss of Master/Slave communication⁶	ORANGE	2 consecutive flashes	- Check Master/Slave connections. - Reset of the system. - If the fault persists, send Master and Slave to Reer laboratories for repair

RECEIVER			
MEANING	TWO-COLOUR (Red/Green)		REMEDY
Incorrect configuration	RED	2 consecutive flashes	- Check connections.
Interfering emitter detected	RED	4 consecutive flashes	Carefully locate the interfering Emitter and take action in one of the following ways: - Reduce the range of the interfering Emitter from High to Low - Swap over the position of Emitter and Receiver - Move the interfering Emitter so that it does not illuminate the Receiver - Shield the beams emitted by the interfering Emitter using opaque protections
OSSD outputs error	RED	5 consecutive flashes	- Check connections. - If the fault persists, send to REER for repair.
Internal failure	RED	6/7 consecutive flashes	- Send the device to Reer laboratories for repair
Incorrect Master/Slave connections⁷	RED	8 consecutive flashes	- Check Master/Slave connections - If the fault persists, send the device to Reer laboratories for repair.

Table 19 - Troubleshooting

In any case, if a system stoppage occurs, switch the system off and on again to check whether the incorrect behaviour of the system is to be ascribed to transitory electromagnetic disturbances.

If the malfunction persists:

- Check that electrical connections are correct and undamaged;

⁵ Indication present only on Slave light curtains

⁶ Indication present only on Master and Slave light curtains

⁷ Indication present only on Master and Slave2 light curtain

- Check that supply voltage levels comply with those indicated in the technical data.
- Check that the Emitter and the Receiver are correctly aligned and that front surfaces are perfectly clean.
- It is advisable to keep the power supply of the light curtain separate from that of other electric power equipments (electric motors, inverters, frequency variators) or other sources of disturbance.

 If it is not possible to trace the cause of the malfunction and eliminate this, stop the machine and contact the Reer assistance service.

If the checks suggested are not sufficient to restore the correct operation of the system, please send the device, with all its parts, to the REER laboratories, clearly indicating:

- product code number (P/N field shown in the product label);
- serial number (S/N field shown in the product label);
- date of purchase;
- period of operation;
- type of application;
- detected fault.

Accessories/Spares

MODEL	ITEM	CODE
AD SR1	ADMIRAL AD SR1 safety module	1330900
AD SRM	ADMIRAL AD SRM safety module with muting function	1330904
AD SR0	ADMIRAL AD SR0 safety relay	1330902
AD SR0A	ADMIRAL AD SR0A safety relay	1330903
CD5	Straight M12 5-pin female connector with 5-m cable	1330950
CD95	90° M12 5-pin female connector with 5-m cable	1330951
CD15	Straight M12 5-pin female connector with 15-m cable	1330952
CD915	90° M12 5-pin female connector with 15-m cable	1330953
CDM9	Straight M12 5-pin female connector PG9	1330954
CDM99	90° M12 5-pin female connector PG9	1330955
C8D5	Straight M12 8-pin female connector with 5m cable	1330980
C8D10	Straight M12 8-pin female connector with 10m cable	1330981
C8D15	Straight M12 8-pin female connector with 15m cable	1330982
C8D95	90° M12 8-pin female connector with 5m cable	1330983
C8D910	90° M12 8-pin female connector with 10m cable	1330984
C8D915	90° M12 8-pin female connector with 15m cable	1330985
C8DM9	Straight M12 8-pin female connector PG9	1330986
C8DM99	90° M12 8-pin female connector PG9	1330987
CDS03	0.3m cable with 2 straight M12 5-pin female connectors	1330990
CJBE3	3m cable with 2 straight M12 5-pin female connectors	1360960
CJBE5	5m cable with 2 straight M12 5-pin female connectors	1360961
CJBE10	10m cable with 2 straight M12 5-pin female connectors	1360962
TR14	Test rod diameter 14mm	1330960
TR20	Test rod diameter 20mm	1330961
TR30	Test rod diameter 30mm	1330962
TR40	Test rod diameter 40mm	1330963
TR50	Test rod diameter 50mm	1330964
SA 4	Set of 4 fastening accessories (brackets, inserts and bolts) for models up to 1050	1310970
SA 6	Set of 6 fastening accessories (brackets, inserts and bolts) for models from 1200	1310971
SAV4E	Set of 4 vibration-damping supports (for models h=150)	1310972
SAV8E	Set of 8 vibration-damping supports (for models h=300÷1050)	1310973
SAV12E	Set of 12 vibration-damping supports (for models h=1200÷1500)	1310974

GUARANTEE

All new EOS4 systems are guaranteed by REER for a period of 12 (twelve) months under normal working conditions, against defects due to faulty materials and workmanship.

During the aforesaid period, REER promises to replace faulty parts free of charge. This guarantee covers both material and labour.

REER reserves the right to decide whether to repair equipment or replace it with equipment of the same type or having the same characteristics.

The validity of this guarantee is subject to the following conditions:

- The user must notify REER of the fault within twelve months following the date of delivery of the product.
- The equipment and all parts thereof must be in the condition in which they were supplied by REER.
- The defect or malfunction must not arise directly or indirectly from:
 - Improper use
 - Non-observance of the instructions for use;
 - Negligence, inexperience, improper maintenance;
 - Repairs, modifications and adjustments carried out by personnel not authorised by REER, tampering, etc.;
 - Accidents or collisions (also during transportation or due to acts of God);
 - Other reasons for which REER cannot be held responsible.

Repairs will be carried out at REER's laboratories, to which the material must be consigned or forwarded: transport costs and any damage or loss of material during transportation will be charged to the Customer.

All replaced products and parts are property of REER.

REER does not recognise any other form of guarantee or rights other than those expressly stated above; no requests for compensation for damages incurred for costs, suspension of activities or any other events or circumstances related in any way to malfunctioning of the product or any parts thereof will be taken into consideration.

 Precise, complete compliance with all the indications and warnings indicated in this manual is essential for correct operation of the light curtain. Therefore, REER s.p.a. declines any responsibility for defects caused by even partial non-compliance with such indications.

Characteristics liable to modifications without prior notice. • Complete or partial reproduction is forbidden without REER's prior authorisation.